

# SWIMSPA OWNER'S MANUAL



**HYDROPOOL**  
hot tubs • swim spas



**Hydropool Inc.**  
**335 Superior Blvd.**  
**Mississauga, ON, Canada L5T 2L6**  
**Tel: 905.565.6810**  
**Toll Free: 1.800.465.2933**  
**Fax: 905.565.6820**  
**Email: [info@hydropoolhottubs.com](mailto:info@hydropoolhottubs.com)**  
**[www.hydropoolhottubs.com](http://www.hydropoolhottubs.com)**

**Contents subject to change without notice**

**2023**

<b>Models Covered</b>	<b>Domestic Model Codes</b>	<b>Export Model Codes</b>
<b>13FFP Aquaplay</b>	<b>SS13FFPAP</b>	<b>SSE13FFPAP</b>
<b>14AX Aqua Sport</b>	<b>SS14ES</b>	<b>SSE14ES</b>
<b>14AX Aqua Trainer</b>	<b>SS14ET</b>	<b>SSE14ET</b>
<b>16EX Executive Sport</b>	<b>SS16ES</b>	<b>SSE16ES</b>
<b>16EX Executive Trainer</b>	<b>SS16ET</b>	<b>SSE16ET</b>
<b>17AX Aqua Sport</b>	<b>SS17ES</b>	<b>SSE17ES</b>
<b>17AX Aqua Trainer</b>	<b>SS17ET</b>	<b>SSE17ET</b>
<b>19EX Executive Sport</b>	<b>SS19ES</b>	<b>SSE19ES</b>
<b>19EX Executive Trainer</b>	<b>SS19ET</b>	<b>SSE19ET</b>
<b>19DTAX Aqua Sport Gold</b>	<b>SS19ASFXDTG</b>	<b>SSE19ASFXDTG</b>
<b>19DTAX Aqua Trainer Gold</b>	<b>SS19ATFXDTG</b>	<b>SSE19ATFXDTG</b>



## TABLE OF CONTENTS

<b>Letter of introduction</b>	4	<b>Topside Panel Display Messages</b>	43
<b>Important User Safety Instructions</b>		<b>Variable Air Therapy System Control Functions</b>	43
Warnings	5		
Hyperthermia	6	<b>Bellagio Control Filter</b>	43
<b>Choosing the Right location</b>		Aquapro AX Current Control	44
Indoor Locations	7	Aquapro EX Current Control	45-48
Outdoor Locations	7	Hydroclear Pure Water System	49
<b>General Installation Considerations</b>	8	UV-C Lamp Replacement Instructions	50
<b>Special Considerations</b>		<b>Swim Spa Water Balance</b>	
Indoor Installations	8	General Overview	51
Outdoor Installations	8	Initial Fill	51
<b>Site Preparation</b>		Glossary of Common Water Maintenance Terms	52
Above Ground Installations	9	Water Balance Summary for your Swim Spa (chart)	52
In-ground & Partial In-ground Installations	9	Water Balance Troubleshooting	53
Overall Support (non-cabinet installations)	9	<b>Routine Hot Tub Maintenance</b>	
Swimspa Frame Shim Installation	10	Daily, Weekly, Monthly, Quarterly	54
Installation Examples	11	Cleaning the Skimmer Basket	54
Equipment Accessibility & Protection	11	Safety Hard Cover	54
Equipment Placement	11	Cartridge Filter, Removal, Cleaning, Re-installation	55
<b>Unloading/Handling your Swim Spa</b>	12	Cleaning the Acrylic Surface	55
<b>Important Electrical Safety Instructions</b>	13-15	Changing your Swim Spa Water	56
G.F.C.I./R.C.D. Application Guideline & Wire Size	13	Draining your Swim Spa Water	56
North America G.F.C.I. Installation Diagram	14	Water Softeners	56
Europe R.C.D. Installation Diagram	15	<b>Hydropool Exclusive Quick-Drain™ and Self Clean Mode Indicator</b>	57
<b>Filling, Checking and Starting your Swim Spa</b>	16-18	<b>Everlast Products</b>	58
Pump Priming/Releasing an Air Lock	17-18	Protecting your Cabinet Everlast Finish	58
<b>Hydropool Control Systems</b>	19-30	Soft Stride Floor System	59
Aquaplay Series Controls	19-22	Care of Stainless Steel	59
Hydropool Swim Spa Series Controls	23-30	<b>Winterizing your Hydropool Hot Tub</b>	60
DTAX Spa Control	24	<b>General Troubleshooting</b>	61
Aquasport / Executive Sport Controls	25	What to do in the event of	
Aquatrainer / Executive Trainer Controls	26	Power Fluctuations	61
Programming	27-30	Cold Weather Power Failure	61
I-Command 2 System (optional)	31-41	<b>Wiring Diagrams (in.ye)</b>	62-65
Standby Mode	42		
Drain Mode	42		

**NOTE: Product specifications, warnings and labels are subject to change without notice. This user's manual should be used as a guide only. For further information, please contact your independent Hydropool dealer.**

On behalf of everyone at the company, we thank you for your decision to purchase a HydroPool swim spa.

Recognized for quality worldwide, we are confident that your new swim spa will provide you, your family and friends, with years of enjoyment and fulfill all your hydrotherapy needs.

HydroPool swim spas are not only healthful and relaxing, they can even add value to your home.

**Please take the time to carefully read and understand all the safety, installation and operating instructions in this manual before electrically connecting your hot tub and adding water.**

The following pages contain valuable information and pointers that will save you both time and money, as well as help you to simplify upkeep and maintenance.

Since manufacturing our first swim spa in 1995, we have seen the popularity of this mini-fitness and massage pool grow by leaps and bounds year after year.

The minimal space and maintenance requirements of swim spas, combined with the year-round use potential, safety and better swim, will ensure the future of swim spas as "the pool of the future".

**Enjoy.**



**David Jackson**

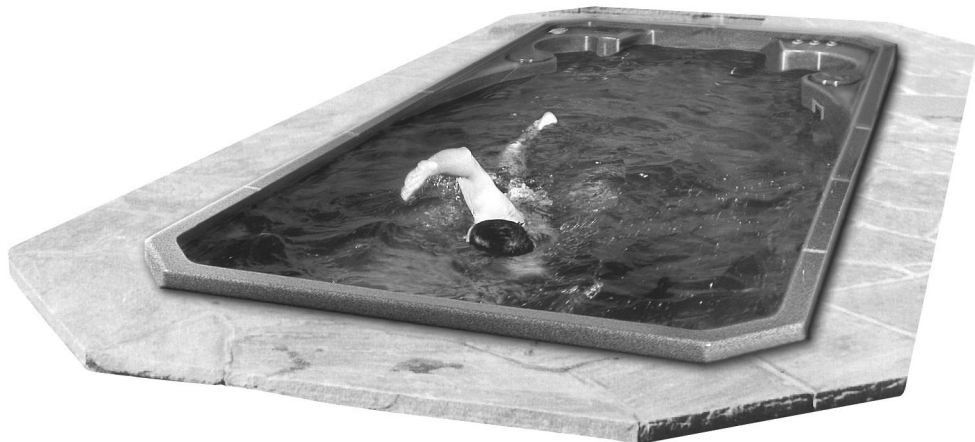



## SAVE THESE INSTRUCTIONS

### IMPORTANT SAVE THESE INSTRUCTIONS

Your physiological response to hot water is subjective and depends on your age, health, and medical history. If you don't know your tolerance to hot water, or if you get a headache, or become dizzy or nauseous when using your hot tub, get out and cool off immediately.



# WARNING

1. CHILDREN SHOULD NOT USE SPAS OR HOT TUBS WITHOUT ADULT SUPERVISION.
2. DO NOT USE SPAS OR HOT TUBS UNLESS ALL SUCTION GUARDS ARE INSTALLED TO PREVENT BODY AND HAIR ENTRAPMENT.
3. PEOPLE USING MEDICATIONS AND/OR HAVING ANY ADVERSE MEDICAL HISTORY SHOULD CONSULT A PHYSICIAN BEFORE USING A SPA OR HOT TUB.
4. PEOPLE WITH INFECTIOUS DISEASES SHOULD NOT USE A SPA OR HOT TUB.
5. TO AVOID INJURY, EXERCISE CARE WHEN ENTERING OR EXITING THE SPA OR HOT TUB.
6. DO NOT USE DRUGS OR ALCOHOL BEFORE OR DURING THE USE OF A SPA OR HOT TUB, TO AVOID UNCONSCIOUSNESS AND POSSIBLE DROWNING.
7. PREGNANT OR POSSIBLE PREGNANT WOMEN SHOULD CONSULT A PHYSICIAN BEFORE USING A SPA OR HOT TUB.
8. WATER TEMPERATURE IN EXCESS OF 38°C (100°F) MAY BE INJURIOUS TO YOUR HEALTH.
9. BEFORE ENTERING THE SPA OR HOT TUB, MEASURE THE WATER TEMPERATURE WITH AN ACCURATE THERMOMETER.
10. DO NOT USE A SPA OR A HOT TUB IMMEDIATELY FOLLOWING STRENUOUS EXERCISE.
11. PROLONGED IMMERSION IN A SPA OR HOT TUB MAY BE INJURIOUS TO YOUR HEALTH.
12. DO NOT PERMIT OR USE ELECTRIC APPLIANCES (SUCH AS LIGHT, TELEPHONE, RADIO OR TELEVISION) WITHIN 1.5M (5FT) OF THIS SPA OR HOT TUB.
13. CHILDREN SHOULD NOT ENTER A HOT TUB WHERE THE WATER TEMPERATURE EXCEEDS BODY TEMPERATURE (37°C / 98.6°F).
14. DO NOT ALLOW CHILDREN TO SUBMERGE THEIR HEAD UNDER WATER.
15. NEVER OPERATE THE HOT TUB PUMP AT HIGH SPEED WITHOUT HAVING ALL SUCTION AND RETURN LINES OPEN.
16. ALWAYS KEEP THE HARDCOVER INSTALLED AND LOCKED WHEN THE HOT TUB IS NOT IN USE.
17. TEST THE GFCI (GROUND FAULT CIRCUIT INTERRUPTER) MONTHLY.
18. POST EMERGENCY PHONE NUMBERS FOR POLICE, FIRE DEPARTMENT, AND AMBULANCE AT THE NEAREST PHONE.
19. TO REDUCE THE RISK OF INJURY
  - THE WATER IN A SPA SHOULD NEVER EXCEED 40°C (104°F). WATER TEMPERATURES BETWEEN 38°C (100°F) AND 40°C (104°F) ARE CONSIDERED SAFE FOR A HEALTHY ADULT. LOWER WATER TEMPERATURES ARE RECOMMENDED FOR YOUNG CHILDREN AND WHEN SPA USE EXCEEDS 10 MINUTES.
  - SINCE EXCESSIVE WATER TEMPERATURES HAVE A HIGH POTENTIAL FOR CAUSING FETAL DAMAGE DURING THE EARLY MONTHS OF PREGNANCY, PREGNANT OR POSSIBLY PREGNANT WOMEN SHOULD LIMIT SPA WATER TEMPERATURES TO 38°C (100°F).
  - BEFORE ENTERING A SPA, THE USER SHALL MEASURE THE WATER TEMPERATURE SINCE THE TOLERANCE FOR WATER TEMPERATURE-REGULATING DEVICES VARIES.
  - THE USE OF ALCOHOL, DRUGS, OR MEDICATION BEFORE OR DURING SPA USE MAY LEAD TO UNCONSCIOUSNESS, WITH THE POSSIBILITY OF DROWNING.
  - OBESE PERSONS AND PERSONS WITH A HISTORY OF HEART DISEASE, LOW OR HIGH BLOOD PRESSURE, CIRCULATORY SYSTEM PROBLEMS OR DIABETES SHOULD CONSULT A PHYSICIAN BEFORE USING A SPA.
  - PERSONS USING MEDICATION SHOULD CONSULT A PHYSICIAN BEFORE USING A SPA SINCE SOME MEDICATION MAY INDUCE DROWSINESS WHILE OTHER MEDICATION MAY EFFECT HEART RATE, BLOOD PRESSURE AND CIRCULATION.

## SAVE THESE INSTRUCTIONS IMPORTANT SAVE THESE INSTRUCTIONS

Your physiological response to hot water is subjective and depends on your age, health, and medical history. If you don't know your tolerance to hot water, or if you get a headache, or become dizzy or nauseous when using your hot tub, get out and cool off immediately.



### CAUTION

1. MAINTAIN WATER CHEMISTRY IN ACCORDANCE WITH THE MANUFACTURER'S INSTRUCTIONS.



### DANGER

1. RISK OF ACCIDENTAL DROWNING. EXTREME CAUTION MUST BE EXERCISED TO PREVENT UNAUTHORIZED ACCESS BY CHILDREN. TO AVOID ACCIDENTS, ENSURE THAT CHILDREN CAN'T USE THE SPA UNLESS THEY ARE SUPERVISED AT ALL TIMES.
2. RISK OF INJURY. THE SUCTION FITTINGS IN THIS SPA ARE SIZED TO MATCH THE SPECIFIC WATER FLOW CREATED BY THE PUMP. SHOULD THE NEED ARISE TO REPLACE THE SUCTION FITTINGS OR THE PUMP, BE SURE THAT THE FLOW RATES ARE COMPATIBLE. NEVER OPERATE THE SPA IF THE SUCTION FITTINGS ARE BROKEN OR MISSING. NEVER REPLACE A SUCTION FITTING WITH ONE RATED LESS THAN THE FLOW RATE MARKED ON THE ORIGINAL SUCTION FITTING.
3. RISK OF ELECTRIC SHOCK. INSTALL AT LEAST 1.5M (5FT) FROM ALL METAL SURFACES. AS AN ALTERNATIVE, A SPA MAY BE INSTALLED WITHIN 1.5M (5FT) OF METAL SURFACES IF EACH METAL SURFACE IS PERMANENTLY CONNECTED BY A MINIMUM 8 AWG (8.4 mm<sup>2</sup>) SOLID COPPER CONDUCTOR TO THE WIRE CONNECTOR ON THE TERMINAL BOX THAT IS PROVIDED FOR THIS PURPOSE.
4. RISK OF ELECTRIC SHOCK. DO NOT PERMIT ANY APPLIANCE, SUCH AS A LIGHT, TELEPHONE, RADIO, OR TELEVISION, WITHIN 1.5M (5FT) OF THE SPA.

#### HYPERTHERMIA

Since your hot tub can be set to reach temperatures of 40°C (104°F), users should be aware that extended submersion in water that exceeds normal body temperature can lead to hyperthermia.

The causes, symptoms and effects of hyperthermia may be described as follows:

Hyperthermia occurs when the internal temperature of the body reaches several degrees above the normal body temperature of 37°C (98.6°F). The symptoms of hyperthermia include drowsiness, lethargy, and an increase in the internal temperature of the body. The effects of hyperthermia include:

- Unawareness of impending hazard
- Failure to perceive heat
- Failure to recognize the need to exit the hot tub
- Physical inability to exit the hot tub
- Fetal damage in pregnant woman
- Unconsciousness resulting in the danger of drowning

If you sense any of the symptoms of hyperthermia, safely exit the hot tub immediately.

### WARNING



THE USE OF ALCOHOL, DRUGS OR MEDICATION CAN SIGNIFICANTLY INCREASE THE RISK OF FATAL HYPERTHERMIA.

**NEVER ALLOW DIVING OR JUMPING  
IN YOUR SWIM SPA**

## CHOOSING THE RIGHT LOCATION

Your HydroPool swim spa can be installed indoors or out, on the ground, in the ground or half-and-half. The following information will assist you in choosing the right location for your individual needs. When making your decision, always remember that swim spas can be enjoyed year-round, indoors or out, regardless of the climate.

### INDOOR LOCATIONS

If members of your family are not cold weather enthusiasts, or if your backyard or patio area is not suitable for a swim spa installation, then an indoor location for your swim spa may be your best or only choice. You may wish to create an exercise/spa area in your home, or install your swim spa in a glass solarium or four-season room adjoining your home. Indoor installations not only add a unique look and appeal to your home, they provide the privacy and controlled climate to ensure that use and enjoyment of your swim spa is maximized. If you should choose an indoor location, you will find further information as outlined in the section **“SPECIAL CONSIDERATIONS FOR INDOOR INSTALLATIONS”**



### OUTDOOR LOCATIONS

For a variety of reasons, outdoor locations are a far more popular choice. Some of the reasons include:

- Limited indoor space
- Delivery complications due to door openings, stairwells, etc.
- Limited budget (indoor installations usually also involve interior home renovations)
- Desire for an outdoor entertainment center
- Swim spa is being installed adjacent to an existing or planned swimming pool

For those who choose an outdoor location, swim spa operating temperatures can be adjusted to match the season. In cooler months, many owners will operate their swim spa in the range of 26-32°C (80-90°F).

During warmer months, an operating temperature of 24-30°C (75-85°F) will provide a refreshing retreat. If you should choose an outdoor location, you will find further information as outlined in the section **“SPECIAL CONSIDERATIONS FOR OUTDOOR INSTALLATIONS”**



## GENERAL INSTALLATION CONSIDERATIONS

- 1 Ensure that your Hydropool Swim Spa is properly supported by either a level concrete pad, or a properly constructed deck capable of supporting 1220 kg/m<sup>2</sup> (250 lbs./ft<sup>2</sup>). If there is a possibility that the pad could shift by freezing/thawing ground movement (such as in clay regions, and/or areas with high water tables) concrete footings extending below the frost line are recommended.
- 2 Decking should be chosen and constructed in a manner that minimizes the chance of slipping or falling.
- 3 If you do not have a factory installed insulated cabinet, it is assumed that you are building your own custom cabinet, tiling or decking in combination with the leg kit package.
- 4 Never suspend the swim spa from a deck or cabinet as personal injury and/or unwarrantable product damage may occur.
- 5 The swim spa equipment and all electrical plugs, outlets and lights within 1.5m (5ft) of the pool must be GFCI protected. Consult your electrician for further details.
- 6 Installation of a safety grab rail or reachable support for use when entering or exiting the swim spa is recommended.
- 7 A nearby garden hose connection is recommended for filling and "topping up" the swim spa.

### Please consider the following:

- a. Always provide a convenient access door for servicing the equipment.
- b. Decking should be constructed to allow future service access around the entire swim spa.
- c. Extra insulation may be added, however, the equipment area must remain unimpeded and have adequate ventilation.
- d. Decking should be chosen and constructed in a manner that minimizes the chance of slipping or falling
- e. When not in use or empty, make sure to cover the swimspa with the hard cover to prevent damage to the acrylic due to overexposure to the sun.

## WARNING



**The swim spa equipment and all electrical plugs, outlets and lights within 1.5m (5ft) of the hot tub must be G.F.C.I protected. Consult your electrician or local electrical authority for further details.**

**Access to the swim spa must always be secured:**

**Outdoors - in accordance with local property by-laws and/or via an approved fence with a self-closing gate and a safety hardcover;**

**Indoors - by a lockable door and a safety hardcover.**

## SPECIAL CONSIDERATIONS

### INDOOR INSTALLATIONS

- It is beneficial to have the swim spa room located near wash room and shower facilities
- The swim spa room should have a floor drain to handle splash water, a window, outside exhaust fan or humidistat controlled exhaust fan for ventilation and a humidifier.
- Consider plumbing a water tap and drain location nearby to facilitate draining and top-up
- Always provide adequate ventilation for the support equipment
- Consult your local Hydropool retailer for further information

### OUTDOOR INSTALLATIONS

- Contact your local building code department to determine if a building permit is necessary and for information on applicable bylaws (distance from property lines, buildings, fencing requirements, etc.)
- If you are doing any excavating, contact your local gas, electric, and cable-company to ensure that there are no underground lines
- Locate the swim spa, where practical, within close distance of a door to the house to maximize potential winter use.
- Ensure that all swim spa support equipment is easily accessible and protected from the elements
- The swim spa support equipment is designed for indoor (out of the direct elements) use. When your **HYDROPOOL** swim spa is equipped with a factory-installed cabinet, and installed as per the guidelines of this manual, the equipment will be adequately protected. If the swim spa is shipped without a cabinet, your custom cabinet or other structure must be designed to supply protection for the swim spa support equipment from rain, snow, splash water, etc., but still designed in a manner to ensure adequate ventilation.

## SITE PREPARATION

### ABOVE-GROUND INSTALLATIONS

Where the swim spa is a "stand-alone" above-ground installation to be installed in regions where freeze/thaw conditions may occur, a level patio stone or pre-formed paver type base may be sufficient if there is no abutting deck(s) that could be damaged during potential seasonal movement of the ground. The potential drawback to this type of base is that splash water could eventually de-stabilize the ground under the base, with the resultant shift of the support base causing damage to the swim spa structure.

For best results, we recommend the installation of a level concrete pad:

- Dig out and level the ground 20-30 cm (8-12 in.) below your desired base level
- Install 10-15 cm (4-6 in.) of crushed stone
- Next, install 10-15 cm (4-6 in.) of poured concrete
- Level the concrete and apply a broom-type finish
- We recommend that the pad be made 15 cm (6 in.) larger than the swim spa on three sides, and 1 m (3 ft.) larger on the side where the access steps and/or planters will be installed.
- Swimspace must be installed on a level pad

In regions where freeze/thaw occurs, or where there will be custom decking abutting the swim spa, we recommend the installation of poured concrete footings extending below the frost line beneath the pad to prevent the possibility of future shifting.

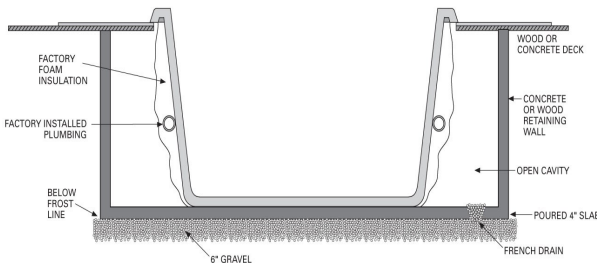

### IN GROUND & PARTIAL IN GROUND INSTALLATIONS

When recessing the swim spa all or part way below ground level, a concrete base along with a concrete or wood retaining wall to hold back the earth is suggested. This forms a box or 'bunker', in which the swim spa is placed. Hydropool does **not** recommend back-filling full in-ground or partial in-ground installations.

Recommended Minimum Concrete Pad Dimensions	
Models	With Factory Cabinet & Steps
13FFP and 14AX	259 cm x 576 cm 102 in x 228 in
16EX and 17AX	259 cm x 671 cm 102 in x 264 in
19EX and 19DTAX	259 cm x 726 cm 102 in x 286 in

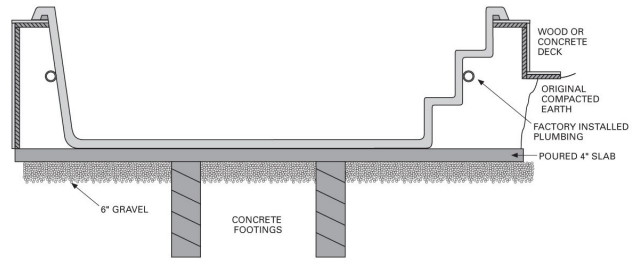

- It is recommended leaving a 61 cm (24 in) wide crawl-space around the entire unit to ensure adequate accessibility.
- Non-freezing climates – it is sufficient to ensure that the base of the hole or cavity created for the swim spa has a dry, stable, compacted level base and proper drainage.
- Climates where freeze/thaw occurs – it is necessary that a poured level reinforced concrete base, complete with concrete footings, be installed as outlined in the section **ABOVE-GROUND INSTALLATIONS**. Areas with a high ground water table – a level concrete base, as well as a concrete or wood retaining wall to hold back the earth, is recommended. This forms a box or 'bunker', in which the swim spa is placed.
- **ALWAYS** ensure that there is good drainage, via a properly designed French (gravel) drain system and/or a sump pump, to prevent ground water flooding damage to the support equipment or structure of the swim spa.
- Install protective waterproof conduit to house any cables that will be buried
- Access for future service must be considered at the time of design and installation. You must be able to access all sides and areas of your swim spa. Difficult access will result in supplemental service labour charges not covered by the factory warranty. Consider easily removable deck materials.
- Make sure the swim spa is tested for 48 hours before you prepare the installation of the surrounding/finish deck around your swim spa. Even though all units are tested in our plant, some transport/site handling damage can occur and we suggest you make sure the swim spa is perfectly waterproof before finalizing your installation.
- It is recommended to backfill the first 12 inches of material with 3/4" gravel to provide proper drainage around the perimeter of the swimspace prior to backfilling with earth.
- If at any point you choose to drain down your swim spa for a long duration make sure that you brace the interior of the shell wall approximately 12" down from the top in order to minimize any stress from the force created by the backfill. In normal conditions, the weight of the water is the opposing force to the earth but when the swim spa is emptied down there is no opposing force and there is the risk of inward bowing which could compromise the structural integrity of the shell.

### OVERALL SUPPORT (non-cabinet installations)

Your Hydropool swim spa is equipped with a factory installed load support substructure, which distributes the weight of the water over the entire foot area of the swim spa. The cabinet, either factory installed or customized on-site, should be decorative only, and not relied on for overall support. Although the lip of the swim spa must be supported to ensure it remains level, never suspend a swim spa from a deck or floor by the outer acrylic edge, as this will lead to product damage and/or serious personal injury.



## SITE PREPARATION (CONTINUED)

### SWIM SPA FRAME SHIM INSTALLATION

With the new frame design it is mandatory to have full support on all the gussets that are located on side of the swim spa to keep it level and prevent bowing of the swim spa shell. Always make sure that the slab is perfectly flat before installing a swim spa. You can use a garden hose and spray water on the slab and look for water puddles. If there is formation of puddles, you must re-work the surface, by adding self-leveling concrete or by buffing down the un-even area. The tolerance for the shim under the gusset is 1/8". Anything greater than that may cause structural issues. When the swim spa is installed on the slab locate the sticker on the swim spa frame to determine where to install the shim. The shim must be installed right under the gussets (the sticker will be installed in the center of the gusset, so it can be used as a guide to align the shim. Simply insert the shim under the frame by hand and then gently tap on it with a hammer to make sure that it is secure under the frame. Then with a utility knife cut the shim flush to the end of the frame. You may not require any shim, if your slab is perfectly flat. If the frame make perfect contact with the ground, you don't need to add the shim. When all the gussets are sitting properly on the ground, you can start filling the swim spa. Every swim spa will be delivered with a package of shims in case they are needed.



## SITE PREPARATION CONTINUED INSTALLATION EXAMPLES

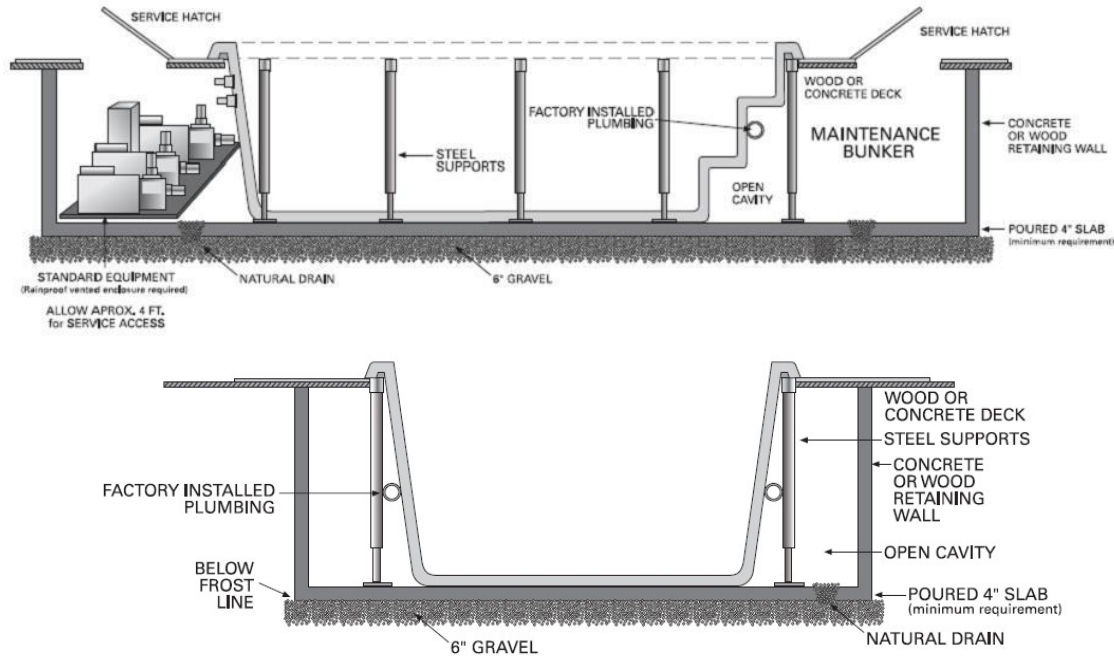

### EQUIPMENT ACCESSIBILITY & PROTECTION

The equipment must be located in an area where it will remain dry and will not be exposed to rain, snow or ground water.

- When your swim spa is to be installed above ground, the optional factory cabinet is designed for both protection and accessibility
- When your swim spa is to be installed fully or partially in the ground, or if you have ordered a swim spa without a cabinet: it is necessary that the equipment be installed in an area that is dry, protected from the elements, has proper ventilation, and is easily accessible for service
- Always ensure that the equipment is mounted on a raised base or platform to prevent potential water damage to the motors, equipment or controls. Note that the equipment is supplied on a raised composite support equipment platform.
- Ensure that access to the equipment, and the working area around the equipment, is large enough to accommodate a service person
- The equipment should be located as close to the swim spa as possible to maximize jet performance
- Whenever possible, install the pump(s) and control with heater below water level to ensure easy priming and maximize performance.
- Install protective waterproof conduit to house applicable cords or line extensions such as the topside control cables, light wires or ozone tubing.
- In climates where freeze/thaw occurs we recommend that remote plumbing lines be buried below the frost line and that pipe insulation is applied over all pipes that run from the swim spa to the remote equipment to help maintain energy efficiency.

### EQUIPMENT PLACEMENT

- The equipment should be located as close to the swim spa as possible to maximize jet performance
- Whenever possible, install the pump(s) and control with heater below water level to ensure easy priming
- Piping diameter on pump lines must be 2.5 in. for inlet/ suction pipes and 2 in. for outlet/pressure pipes with minimal use of elbows.
- Install protective waterproof conduit to house applicable cords or line extensions such as the topside control cables, light wires or ozone tubing.

**The swim spa equipment is designed for indoor use out of the direct elements. Your custom enclosure or other structure must be designed to provide protection for the swim spa support equipment from rain, snow, splash water, etc., but still designed in a manner to ensure adequate ventilation.**

- All field installed plumbing must meet minimum sizes as previously outlined in order to conform to regulated standards regarding safe inlet and outlet flows. If required, please call your dealer for more detailed drawings.

## UNLOADING / HANDLING YOUR SWIM SPA

All Hydropool swim spas are shipped with a layer of protective foam wrap and plastic film. Each swim spa is shipped from the factory strapped onto a wood skid. If your swim spa is to be delivered by your local Hydropool retailer, it will generally arrive on a flat bed truck or low profile trailer. Typically, the dealer will arrive with the necessary equipment to maneuver the swim spa from the truck.

For direct deliveries, your swim spa may arrive on a 48 ft. or 53 ft. common carrier closed box trailer. It may be necessary to arrange with a local towing company for a tilt and load flatbed truck with a winch system, to pull the unit from the box trailer to the flatbed. The swim spa can then be gently slid off the flatbed truck or lifted by a crane into place.

Although it is recommended to install your swim spa by crane, it may be pushed along rollers by 10 to 12 able-bodied adults (see image below), trailered, or craned to its final installation site. If rollers are to be utilized, we recommend that at least six 4" pipes, 8' long, be placed under the shell to move it across a soft lawn, down a path, etc.

Some installations require the use of a crane. When a crane is used for lifting, place the straps under the swim spa, ensuring that the plumbing lines and fittings are not stressed and/or damaged. The straps should be secured so that they will not slip in any direction, and strap spreaders utilized to prevent undue structural side load on the swim spa shell.

Hydropool swim spas require a minimum clearance of 249 x 143 cm (98 x 56 in.) to allow movement of the unit through alley-ways, fence openings, etc. Where this is not possible, the use of a crane (with strap spreaders) to lift the swim spa from the truck or trailer over the house to the patio or yard is often the most viable option.



### WARNING

- Do not move or place the swim spa on the side
- Never lift or handle the swim spa by the plumbing
- Make sure that there is sufficient assistance to gently slide the swim spa off the dolly or cart to the support base without any damage

**Important Note:** Damage caused during transportation or by improper handling is not covered by the factory warranty.

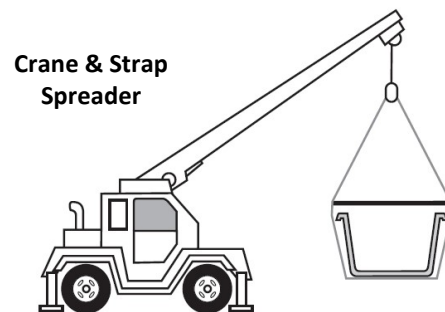
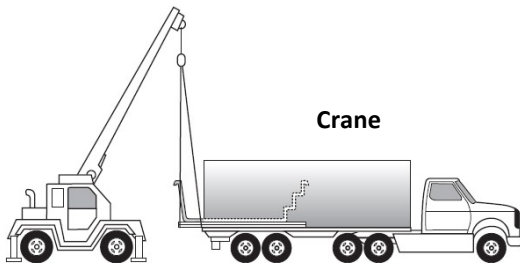





## IMPORTANT ELECTRICAL SAFETY INSTRUCTIONS

**SAFETY COMES FIRST. WHEN INSTALLING & USING THIS ELECTRICAL EQUIPMENT,  
BASIC SAFETY PRECAUTIONS MUST ALWAYS BE FOLLOWED!**

### 1 READ AND FOLLOW ALL INSTRUCTIONS

2 Electrical installation must be completed by a qualified electrician in accordance with all National, Regional and Local Codes and Regulations in effect at the time of installation.

3 Connect only to a dedicated circuit protected by a class 'A' two-pole ground fault circuit interrupter (GFCI)

### 4 Use copper conductors only!

5 The hot tub equipment and all electrical plugs, outlets and lights within 1.5m (5ft) of the unit must be G.F.C.I protected. Consult your electrician or local electrical authority for further details.

6 A green colored terminal or a terminal marked "G", "GR", "Ground", or "Grounding" is located inside the supply terminal box or compartment. To reduce the risk of electric shock, this terminal must be connected to the grounding means provided in the electric supply service panel with a continuous copper wire equivalent in size to the circuit conductors supplying the equipment.

7 At least two lugs marked "**BONDING LUGS**" are provided on the external surface or on the inside of the supply terminal box or compartment. To reduce the risk of electric shock, connect the local common bonding grid in the area of the hot tub to these terminals with an insulated or bare copper conductor not smaller than No.6 AWG (Canada/Europe) / No.8 AWG (USA).

8 All field installed metal components such as rails, ladders, drains or other similar hardware within 3 m (10 ft) of the hot tub shall be bonded to the equipment grounding bus with copper conductors not smaller than No.6 AWG.

### IMPORTANT NOTE:

- This guide is for standard installations where the wire run is 15 m (50 ft.) or less. For longer wire runs, consult a qualified electrician.

### G.F.C.I./R.C.D. APPLICATION GUIDE FOR HYDROPOOL SWIM SPA SERIES

<b>NORTH AMERICA</b>	
Aquaplay/Aquasport/Executive Sport	50A
Aquasport 19DTAX Gold	40A spa / 50A swim
Aquatrainner/Executive Trainer	60A
Aquatrainner 19DTAX Gold	40A spa / 60A swim
<b>EUROPE (single phase)</b>	
Aquaplay/Aquasport/Executive Sport	40A
Aquasport 19DTAX Gold	20A spa / 40A swim
Aquatrainner/Executive Trainer	40A
Aquatrainner 19DTAX Gold	20A spa / 40A swim

## WIRE SIZE

### NORTH AMERICA

- The minimum wire size for systems that require a 40A GFCI is # 8/3 c/w ground (also referred to as # 8 gauge / 4 conductor).
- The minimum wire size for systems that require a 50A GFCI is # 8/3 c/w ground (also referred to as # 8 gauge / 4 conductor).
- The minimum wire size for systems that require a 60A GFCI is # 6/3 c/w ground (also referred to as # 6 gauge / 4 conductor).

### EUROPE

Standards for amperage breakers may vary from country to country in the CE controlled area. Please consult your local installer for advice on breaker level and wire specifications. Some examples are below:

Breaker of 13A—wire must be 1.5 mm<sup>2</sup>

Breaker of 16A—wire must be 2.5 mm<sup>2</sup>

Breaker of 20A—wire must be 4.0 mm<sup>2</sup>

Breaker of 32A—wire must be 6.0 mm<sup>2</sup>

**NOTE: Please consult your applicable electrical codes related to the size of conductors as they may vary from what is stated above. Take into consideration the length of cable as well and increase as required.**

## NORTH AMERICA – GFCI INSTALLATION



# NOTICE

Installation of the GFCI - Circuit Breaker, including ampere sizing and selection of conductor size and type, must be performed by a qualified electrician in accordance with the National Electrical Code, or the Canadian Electrical Code, and all Federal, State/Provincial and local codes and regulations in effect at the time of installation. HydroPool highly recommends the use of a new Siemens GFCI breaker for all of its products. Other GFCI's and older Siemen's GFCI's may have tripping issues.

### 240 VOLT 60Hz AQUASPORT SINGLE GFCI WIRING (MAIN ONLY)

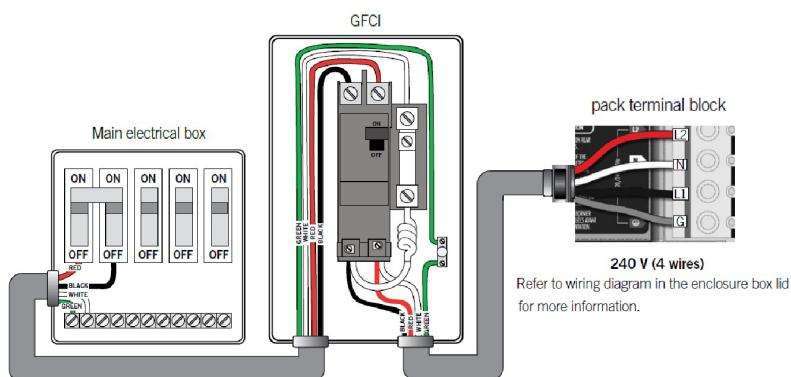

### 240 VOLT 60 Hz SWIMSPA SINGLE GFCI WIRING MAIN / AUXILLIARY HEATER

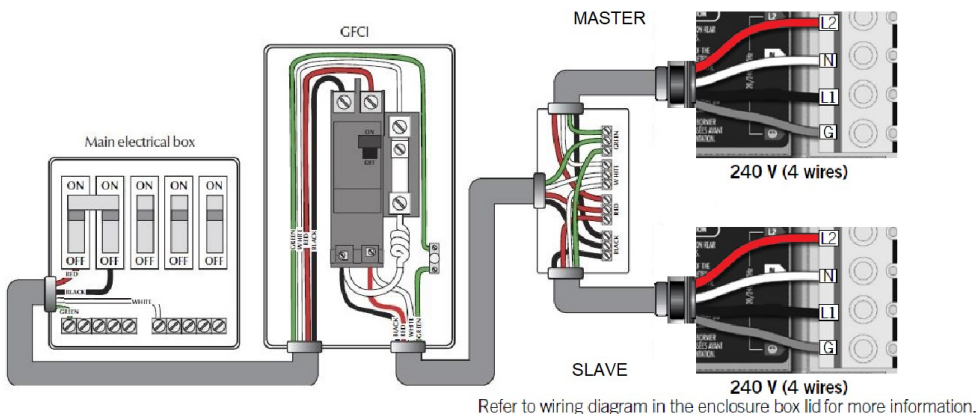

### 240 VOLT 60 Hz SWIMSPA DUAL GFCI WIRING MAIN / AUXILLIARY HEATER

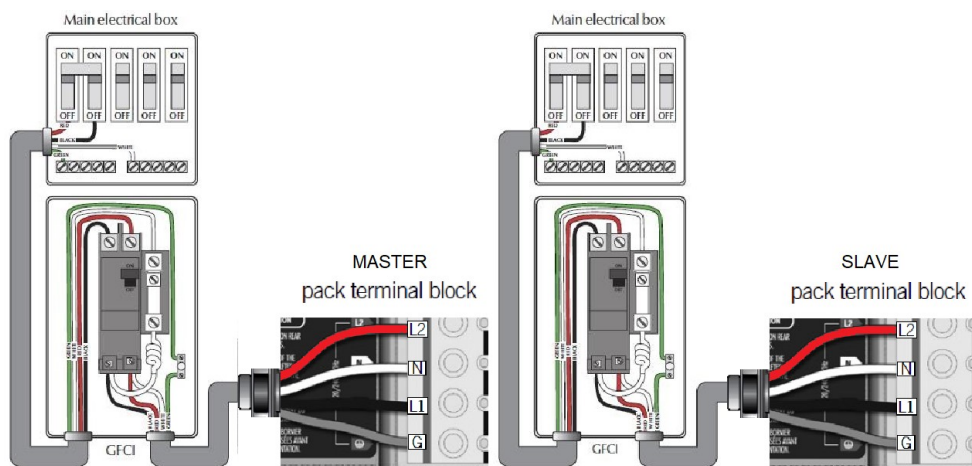

240 V (4 wires) Refer to wiring diagram in the enclosure box lid for more information.

## EUROPE – R.C.D. INSTALLATION - TYPICAL



# NOTICE

**Important Note:** Installation of the R.C.D. - Circuit Breaker, including ampere sizing and selection of conductor size and type, must be performed by a qualified electrician in accordance with National, Regional and Local Codes and Regulations in effect at the time of installation.

### 230 VOLT 50 Hz SINGLE PHASE RCD WIRING

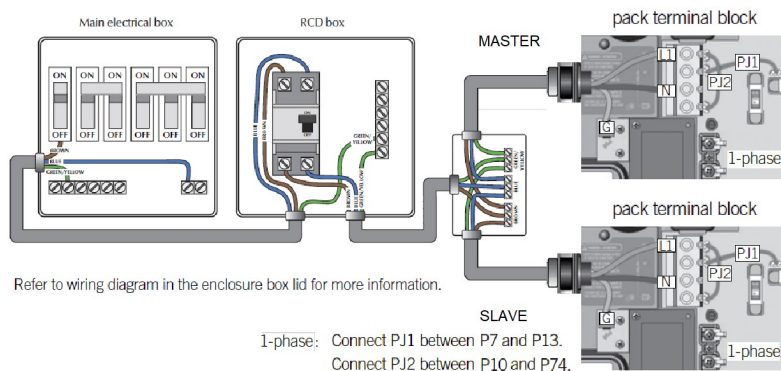

### 230 VOLT 50 Hz DUAL PHASE RCD WIRING

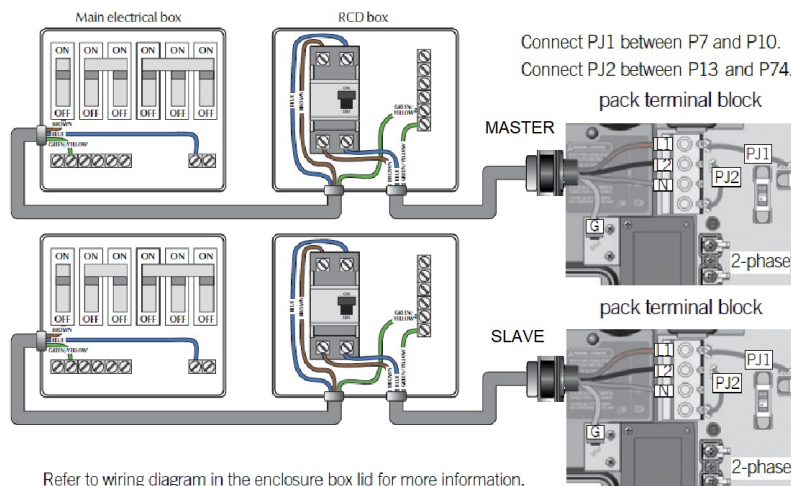

### 230 VOLT 50 Hz THREE PHASE RCD WIRING

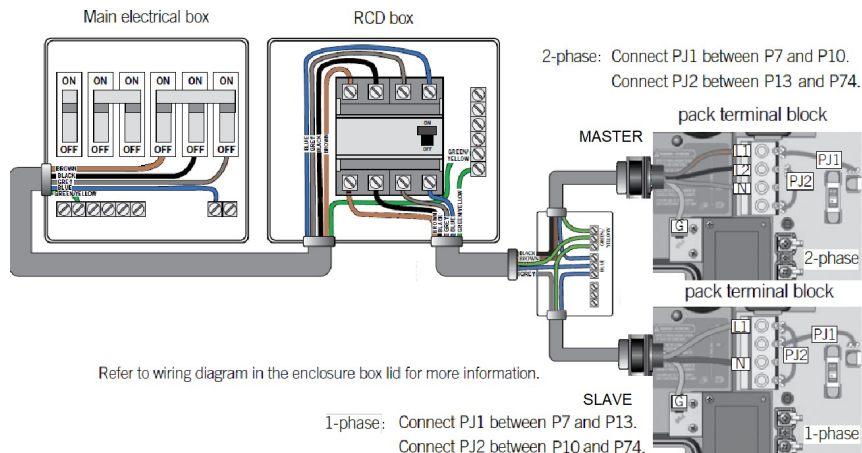

## FILLING, CHECKING AND STARTING YOUR SWIM SPA—13FFP



### FILLING

- When adding water for the first time, the hot tub should be filled through the skimmer opening (helps to prevent air locks) using a standard garden hose, turning the tap on slowly to prevent damage to the surface by a jerking hose connection.
- Ensure the handles on the intake and return gate valves are pulled up and stem locks are in place.
- Ensure the drain hose-bib is closed.
- Ensure that all jets are open.
- Fill the hot tub to the recommended level, approximately 4 inches above the top of the skimmer opening.



### CHECKING

- Although your hot tub was thoroughly water-tested in the factory, some loosening of fittings can occur during shipping. Before any decking, tiling or carpeting is completed around the installation, fill and operate your hot tub to test for leaks (this ensures easy access and inexpensive correction). Check all union connections and plumbing for minor leaks. In the event of a leak, ensure all union connections and pump plugs are tight and all o-rings/gaskets are in place.

### STARTING

- Before applying voltage to power-up your hot tub, it is very important that you understand the sequence of events that occur when the system is activated in order that the pump can be primed efficiently and damage to the system can be avoided.



**PROPER WATER LEVEL AT  
SKIMMER OPENING**

- Turn the main power “on” at your electrical panel.
- Follow the control instructions for your particular model hot tub to put the pump into low speed **see section HYDROPOOL CONTROL SYSTEMS PUMP PRIMING/ RELEASING AN AIR LOCK**
- On some systems a message will appear on the display indicating that the system is in **PUMP PRIMING MODE (“RUN PMPS PURG AIR”)**. This mode will last for 4 minutes before automatically entering the normal operation mode. **See complete details for your spa in section HYDROPOOL CONTROL SYSTEMS**

**Definition:** ‘Priming’ a pump is a term used to describe the process in which air trapped in the plumbing and pump wet-end (referred to as an ‘air lock’) is released, allowing the pump to move water efficiently through the plumbing system and to the jets.



## FILLING, CHECKING AND STARTING YOUR SWIM SPA—ALL OTHER SWIMSPAS



### CHECKING

Although your swim spa was thoroughly water-tested in the factory, some loosening of fittings can occur during shipping. Before any decking, tiling or carpeting is completed around the installation, fill and operate your hot tub to test for leaks (this ensures easy access and inexpensive correction). Check all union connections and plumbing for minor leaks. In the event of a leak, ensure all union connections and pump plugs are tight and all o-rings/gaskets are in place.



### STARTING

Before applying voltage to power-up your swim spa, it is very important that you understand the sequence of events that occur when the system is activated in order that the pump can be primed efficiently and damage to the system can be avoided.

- Turn the main power “on” at your electrical panel.
- Follow the control instructions for your particular model swim spa to put the pump into low speed.

See section **HYDROPOOL CONTROL SYSTEMS**

### PUMP PRIMING/RELEASING AN AIR LOCK

- On some systems a message will appear on the display indicating that the system is in **PUMP PRIMING MODE**.

This mode will last for 4 to 5 minutes before automatically entering the normal operation mode. See **complete details for your spa in section HYDROPOOL CONTROL SYSTEMS**

When the pump is located below water level, the water should start circulating immediately. If the motor works but if you do not notice water circulation within the first 15 seconds, the pump may require priming due to trapped air (referred to as an ‘air lock’). To prime (inset 2), open the hose -bib to allow trapped air to escape. Close as soon as the water flow from the jets becomes regular. If the pumps have not primed after 2 minutes, and water is not flowing from the jets, **DO NOT** allow the pumps to continue to run. Turn power off at the main house panel (or GFCI) and try releasing the air again by loosening the union on the discharge side of the pump(s) while the motor is not running. Turn the power back on. If the pump(s) does not prime after 15 seconds, sometimes momentarily turning the pump(s) off and on will help the system to prime (note: do not do this more than 5 times). Repeat if necessary.

- **Important:** Under NO circumstances should the pump(s) be allowed to operate without priming beyond 5 minutes, as this may not only cause unwarrantable damage to the pump, it may also cause the control system to go into an overheat condition.

**Definition:** ‘Priming’ a pump is a term used to describe the process in which air trapped in the plumbing and pump wetend (referred to as an ‘air lock’) is released, allowing the pump to move water efficiently through the plumbing system and to the jets.

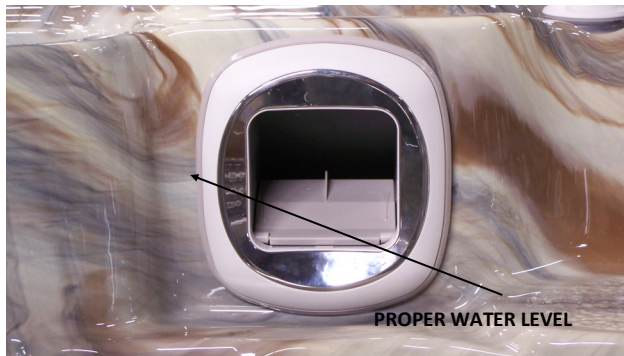

### FILLING

- When adding water for the first time, the swim spa should be filled through the skimmer opening (helps to prevent air locks) using a standard garden hose, turning the tap on slowly to prevent damage to the surface by a jerking hose connection.
- Pull up the handles on the intake and return gate valves and clip on the stem locks. (handles are pulled up when valves are open and pushed down when valves are closed).
- Ensure the drain valve is closed.
- Ensure that all jets are open.
- Fill the swim spa to the recommended level as indicated by the “MIN” and “MAX” marks on the weir door of the skimmer opening.

### RELEASING AIR TRAPPED IN FILTER...

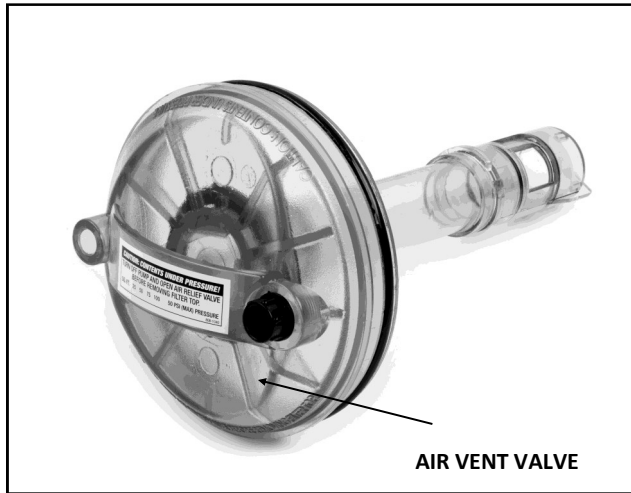

- When the pump starts circulating, it will be necessary to release trapped air in the filter. Carefully loosen the air vent valve counter-clockwise until there is the hissing sound of air escaping. Once there is a steady stream of water, close the vent valve, ensuring that the o-ring does not become pinched.
- Turn the Hydrotherapy pump(s) on and re-check for leaks. The control system will automatically return the pump(s) off after 15 minutes.
- Adjust the hot tub heat control at the topside panel to the desired water temperature.
- Adjust water balance (pH, TA, calcium hardness) to recommended levels and add sanitizer once the water temperature reaches 20°C (68°F).

...THROUGH THE PUMP UNION

### RELEASING AN AIR LOCK...



See section **SWIM SPA WATER BALANCE**

- Keep insulated safety hard cover on the hot tub, and the air controls closed during the entire heat up process.

**NOTE:**

**In order to prevent damage to your pillows caused by the gassing effect of the chemicals, we do recommend to remove them when the spa is not in use. By removing them you will extend considerably the life length of your pillows. We do design ours pillows to be removed easily in order to make sure they will not remain in the spa when it's not in use.**

## HYDROPOOL SWIMSPA AQUAPLAY SERIES CONTROL SYSTEMS



### INITIAL START-UP

Before applying voltage to power-up your hot tub, it is very important that you understand the sequence of events that occur when the system is activated in order that the pump(s) can be primed efficiently and damage to the system can be avoided.

### PROGRAM MENU

The program menu is accessible by holding down the Light Key for 5 seconds. In the Program Menu the following parameters can be set: clock, filter or purge cycles, economy mode and temperature units. While in the program menu, use the Up and Down keys (Up/ Down Key) to adjust the parameters and the Light key to jump to the next parameter. The changes will be saved after the confirmation of the last parameter only. If there is no action taken for 10 seconds, the system will exit the program menu without saving any changes.

### SETTING THE CLOCK TIME

Enter the program menu by holding down the Light Key for 5 seconds. The display will show the current clock setting with the hour flashing. Use the arrow keys to adjust the hour. Press the Light Key to adjust the minutes. Press the light key to jump to the next parameter or to the end of the parameters to save the time.

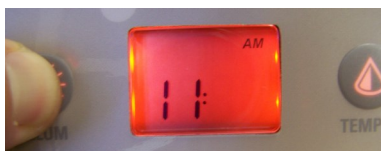

### TEMPERATURE CONTROL FUNCTIONALITY AND ADJUSTMENT



After you exit the programming mode your hot tub will automatically heat to the factory preset default temperature of 38°C (100°F).

The temperature shown on the screen is the current water temperature. Use the UP and DOWN buttons to set the desired temperature.

The set point icon will appear at the top of the screen. After 3 seconds without any change to the set temperature value, the keypad will resume the normal display.

### STANDBY MODE

Pressing the JET key for 5 seconds will enable the Standby Mode. This mode allows you to stop all outputs including automatic functions such as the filter cycle, heat request and smart winter mode for 30 minutes to perform quick spa maintenance. When active, the display will toggle between the "OFF" message, the clock and water temperature.



**HYDROPOOL SWIMSPA AQUAPLAY SERIES CONTROL SYSTEMS**  
**NORTH AMERICA / EUROPE**  
**13FFP MODEL**



**KEYPAD FUNCTIONS AND DISPLAY ICONS**



**JET 1 KEY WHICH  
CONTROLS PUMP 1**



**JET 2 KEY WHICH  
CONTROLS PUMP 2**

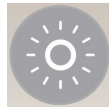

**ILLUM KEY WHICH CONTROLS THE  
LIGHTING AND THE PROGRAMMING**

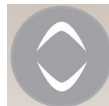

**TEMP UP/ DOWNKEY WHICH CONTROLS  
THE TEMPERATURE**



**HYDROPOOL SWIMSPA AQUAPLAY SERIES CONTROL SYSTEMS GECKO IN.YE3  
NORTH AMERICA / EUROPE**

**PROGRAMMING THE  
FILTER / PURGE CYCLES**



The filter cycle menu consists of the following parameter: the start time (FS), the duration (Fd), and the frequency (FF).

**NOTE:** A filter cycle consists of starting all the pumps and blower (if equipped) in high speed for 1 minute (purge step) then the pump associated with the filter cycle will run in low speed for the remaining duration of the filter cycle (clean up step).

**SETTING THE FILTER CYCLE**



After you have programmed the clock, the next parameter is the filter cycle start time. The display will show FSxx, with "xx" representing the starting hour of the cycle. Use the arrow keys to adjust the hours. Use the Light Key to jump to the next parameter, filter duration (Fd).



The display will show Fdxx, with "xx" representing the duration in hours of the filter cycle. Use the arrow keys to adjust the duration. Use the Light Key to jump to the next parameter, filter frequency (FF).

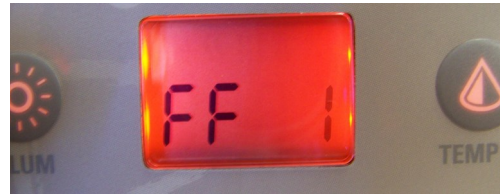

The display will show FFxx, with "xx" representing the number of cycles per day. Use the arrow keys to adjust the frequency. Use the Light Key to jump to the next parameter, economy mode (EP)

This mode allows you to lower the temperature set point of the spa by 20F (11C) during a certain period of the day.



The display will show Epx, with "x" representing the state of the programming (0 = disabled, 1 = enabled). Use the arrow keys to enable or disable the economy mode. Use the light key to jump to the next parameter, economy start time (ES).



When the Economy mode in ON, the display will toggle between the "Eco" message, the time and the water temperature.

## HYDROPOOL SWIMSPA AQUAPLAY SERIES CONTROL SYSTEMS NORTH AMERICA / EUROPE



The display will show Edxx, with “xx” representing the duration in hours of the economy mode. Use the arrow keys to adjust the hour. Use the Light Key to jump to the next parameter, temperature unit.



Water temperature can be displayed in either Fahrenheit (°F) or Celsius (°C). The display will show °F or °C. Use the arrow keys to change the setting. Use the Light Key to save all the parameters.

### SMART WINTER MODE

Smart Winter Mode protects your system from the cold by turning the pumps on several times a day to prevent water from freezing in the pipes. The Smart Winter Mode indicator turns on when in this mode of operation. If the temperature drops to 4°C (39°F) within the heater chamber, the system automatically activates the pump to provide freeze protection. The pump will operate until the temperature reaches 5°C (41°F) before returning to normal system mode.

### COOLING DOWN

After heating the spa water to the desired set point, the heater is turned off, but the filtration pump remains on for a certain amount of time to ensure adequate cooling of the heating element in order to prolong the useful life of the heater. The heater icon flashes during this time.

### PUMP 1 FUNCTION

Press this key (JET or JET 1) to activate the pump

1st press – low speed (**indicator light flashes**)

2nd press – high speed (**indicator light on solid**)

3rd press – turns off (**indicator light off**)

### PUMP 2 FUNCTION

Press this key (JET 2) to activate the pump

1st press – high speed (**indicator light on solid**)

2nd press – turns off (**indicator light off**)

### PUMPS AUTOMATIC TIME-OUT

**Time out** – 30 minutes

### LIGHT FUNCTION

Press this pad to activate the light

1st press: rotating colours

2nd press: solid blue colour

3rd press: solid green colour

4th press: solid red colour

Note: Pressing the light key in intervals less than five seconds will scroll to the next colour. Once you have selected the colour another press will turn the light off.

### LIGHT AUTOMATIC TIME-OUT

**Time out** – 60 minutes



## HYDROPOOL SWIM SPA SERIES CONTROL SYSTEMS NORTH AMERICA / EUROPE



### INITIAL START-UP

Before applying voltage to power-up your hot tub, it is very important that you understand the sequence of events that occur when the system is activated in order that the pump(s) can be primed efficiently and damage to the system can be avoided.

At initial power-up, the system will show the following screen.

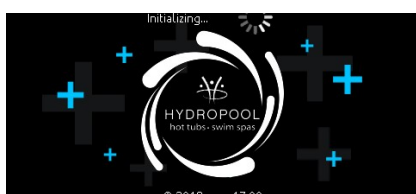

The keypad does store the date and time for a limited time so when the system starts up after a loss of power it may be necessary to reprogram the time and date if the power down duration is greater than 48 hours.

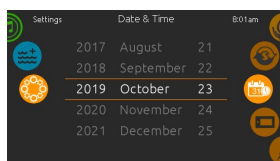
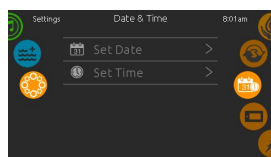

### PROGRAMMING THE DATE AND TIME

Here you can adjust the time format (AM/PM or 24h), day of the week and time. Use the icons to choose the setting that you want to adjust and select it by scrolling through the menu.

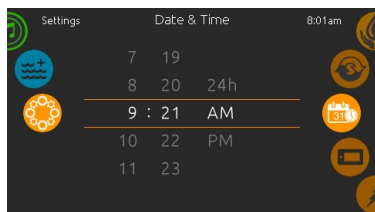

### TEMPERATURE CONTROL FUNCTIONALITY AND ADJUSTMENT

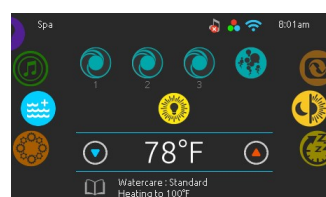

After you exit the programming mode your hot tub will automatically heat to the factory preset default temperature of 38°C (100°F).

The temperature shown in white on the screen is the current water temperature. Use the UP and DOWN icon to set the desired temperature.

The set point will appear in blue on the screen. After 3 seconds without any change to the set temperature value, the keypad will resume the normal display of messages.

When the set value is lower than the current temperature "Cooling to XX°F ("C)" will appear. When the value is set higher than the current temperature, "Heating to XX°F ("C)" will be indicated.

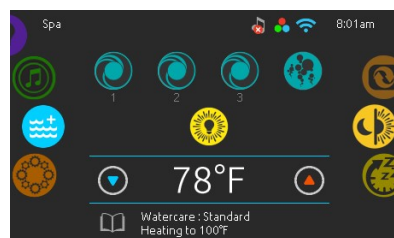

**HYDROPOOL SWIM SPA SERIES CONTROL SYSTEMS**  
**19DTAX SPA CONTROL**



**KEYPAD FUNCTIONS AND DISPLAY ICONS**

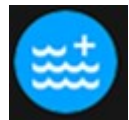

**SPA  
FUNCTION  
KEY**



**SETTINGS  
FUNCTION  
KEY**



**QUICK START /  
STOP KEY**



**PUMP 1  
FUNCTION  
KEY**



**BLOWER  
FUNCTION  
KEY**



**LIGHT  
FUNCTION  
KEY**



**TEMP  
UP  
KEY**



**TEMP  
DOWN  
KEY**

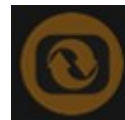

**INVERT  
DISPLAY  
KEY**



**DAY  
NIGHT  
CONTRAST**



**SLEEP  
MODE  
KEY**

**HYDROPOOL SWIM SPA SERIES CONTROL SYSTEMS**  
**AQUASPORT AND EXECUTIVE SPORT SERIES CONTROLS**



**KEYPAD FUNCTIONS AND DISPLAY ICONS**

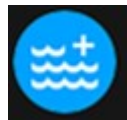

**SPA  
FUNCTION  
KEY**



**SETTINGS  
FUNCTION  
KEY**



**QUICK START /  
STOP KEY**



**PUMP 1  
FUNCTION  
KEY**



**PUMP 2  
FUNCTION  
KEY**



**BLOWER  
FUNCTION  
KEY**



**LIGHT  
FUNCTION  
KEY**



**TEMP  
UP  
KEY**



**TEMP  
DOWN  
KEY**

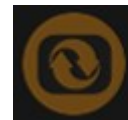

**INVERT  
DISPLAY  
KEY**



**DAY  
NIGHT  
CONTRAST**



**SLEEP  
MODE  
KEY**



**HYDROPOOL SWIM SPA SERIES CONTROL SYSTEMS**  
**AQUATRAINER AND EXECUTIVE TRAINER SERIES CONTROLS**



**KEYPAD FUNCTIONS AND DISPLAY ICONS**

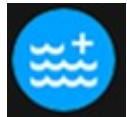

**SPA  
FUNCTION  
KEY**



**SETTINGS  
FUNCTION  
KEY**



**QUICK START /  
STOP KEY**



**PUMP 1  
FUNCTION  
KEY**



**PUMP 2  
FUNCTION  
KEY**



**PUMP 3  
FUNCTION  
KEY**

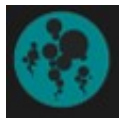

**BLOWER  
FUNCTION  
KEY**



**LIGHT  
FUNCTION  
KEY**



**TEMP  
UP  
KEY**



**TEMP  
DOWN  
KEY**

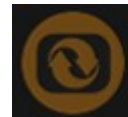

**INVERT  
DISPLAY  
KEY**



**DAY  
NIGHT  
CONTRAST**



**SLEEP  
MODE  
KEY**

### PUMP 1 FUNCTION

Press this pad to activate the pump

- 1st press – high speed (**icon rotates fast**)
- 2nd press – turns off

### PUMP AUTOMATIC TIME-OUT

**High speed** – 15 minutes

### PUMP 2 & 3 FUNCTION (if included)

Press this pad to activate the pump

- 1st press – high speed (**icon rotates fast**)
- 2nd press – turns off

### PUMP AUTOMATIC TIME-OUT

**High speed** – 15 minutes

### LIGHT FUNCTION

Press this pad to activate the light

- 1st press: rotating colours
- 2nd press: solid blue colour
- 3rd press: solid green colour
- 4th press: solid red colour

**Note:** Pressing the light key in intervals less than three seconds will scroll to the next colour. Once you have selected the colour another press will turn the light off.

### LIGHT AUTOMATIC TIME-OUT

**Time out** – 60 minutes

### SETTINGS KEY

From the home page you can access the Settings, where you will find:

- Water Care
- Maintenance
- Day & Time
- Keypad
- Settings
- Miscellaneous
- Electrical Configuration
- About

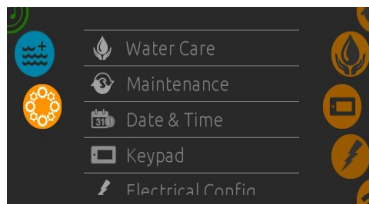

Use the icon keys to scroll up and down in the list. To select an option, press the text.

At any point you can press the Spa Function icon to return to the home screen.



### WATER CARE

The Water Care section will help you set up your ideal filtration and heating settings. Choose from Away, Beginner, Energy Savings, Super Energy Savings and Weekender, depending on your needs.

Use the Light key to choose your setting. A checkmark will appear on the selected icon to confirm.

In Energy Savings mode, the set point will be reduced by 20°F (11°C), which means that the heating system will not be engaged unless the temperature falls to 20°F (11°C) below the spa's set temperature.

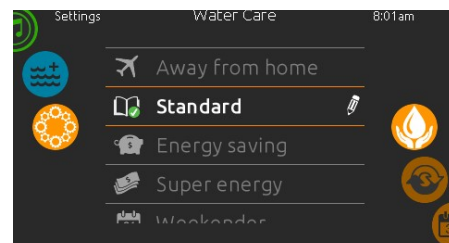

### Water Care Modes:

#### Away:

In this mode the spa will always be in economy; the set point will be reduced by 20°F (11°C) and the filtration can be reduced.

#### Beginner:

The spa will never be in economy mode, and will run a normal 24 hours of filtration a day.

#### Energy Savings:

The spa will be in economy mode during the peak hours of the day and resume normal mode on the weekend.

#### Super Energy Savings:

The spa will always be in economy mode during peak hours, every day of the week.

#### Weekender:

The spa will be in economy mode from Monday to Friday, and will run normally on the weekend.

## MODIFYING SCHEDULES

To see and / or modify the Water Care category, use the Settings icon to open the selected Water Care menu.

Scroll through the menu to choose a schedule to modify (choice of economy and filtration schedules).

You have several possibilities for the schedule (Mon-Fri, weekend, every day, or single days). The schedules will be repeated every week. The time and duration are set in 30 minute increments. Once you have set the schedule, use Spa Function Icon to go back. Ensure that you have selected the desired Water Care option in the main Water Care menu.

The filtration schedule shown on the screen will apply to the main filtration pump. Your spa uses a circulation pump configured to run 24 hours by default and the screen will show you the purge setting instead of filtration. The purges are pre-programmed for a fixed number of minutes, therefore the duration will be set to N/A on the screen, and only the start time can be modified.



## FILTERING

Your spa is equipped with a circulation pump that filters your water for 24 hours a day. If the water temperature exceeds the set temperature by 4°F (and set point is 95°F or higher) then this pump will shut off automatically until the temperature drops below the set point by approximately 1.5°F.

You can bypass the pack filtration over-temperature feature. When Warm weather is "Off", the filtration over-temperature is disabled. This feature allows the spa to continue filtering even through the water temperature is high.

## MAINTENANCE

From the Settings page you can access the Maintenance Menu, which gives you access to the following options:

- Maintenance reminders
- Standby

Press the text to make a selection.

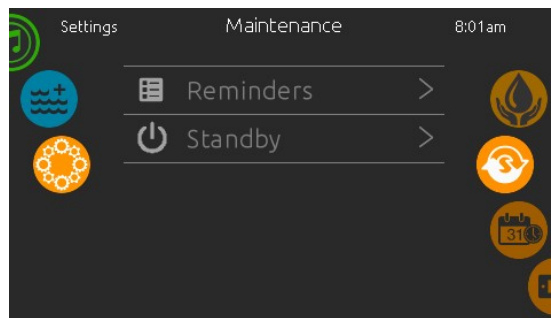
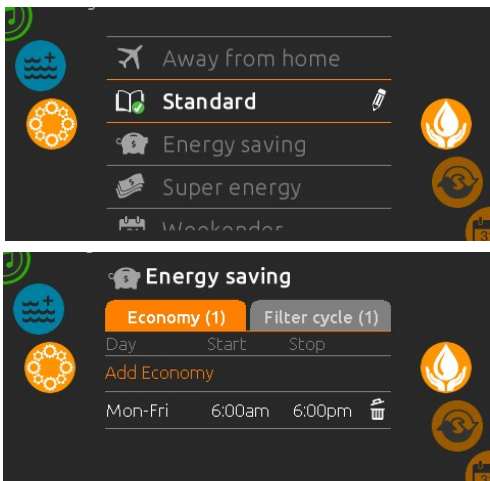



## MAINTENANCE REMINDERS

The keypad will remind you of maintenance required on your spa, like rinsing or cleaning the filter. Each task has its own duration, based on normal use.

The Maintenance Reminders menu allows you to verify the time left before maintenance is required, as well as to reset the time once a task is completed.

Scroll through the menu to move through the list.

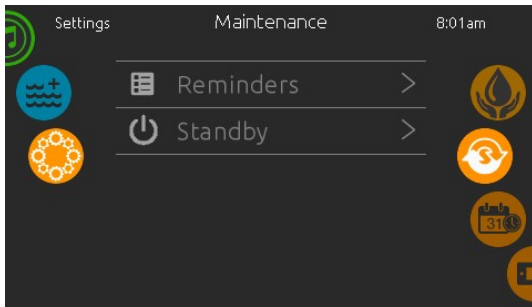

## STANDBY

The Standby mode allows you to service your spa. Pumps will stop for 30 minutes, and automatically restart after this time.

Once Standby mode has been activated a screen will appear to show the pumps are stopped. The normal spa page will return at the end of the maintenance.

Press Cancel to leave Standby mode and restart the spa.

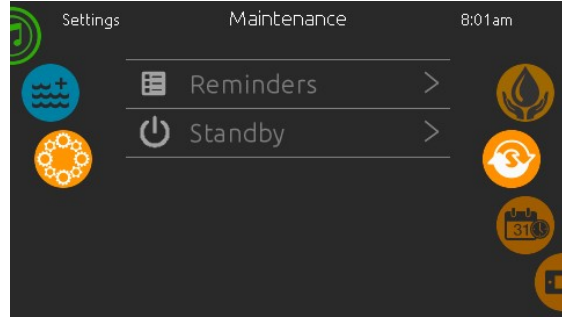

## DATE AND TIME

Here you can adjust the time format (AM/PM or 24h), day of the week and time. Use the icons to choose the setting that you want to adjust and select it by scrolling through the menu.

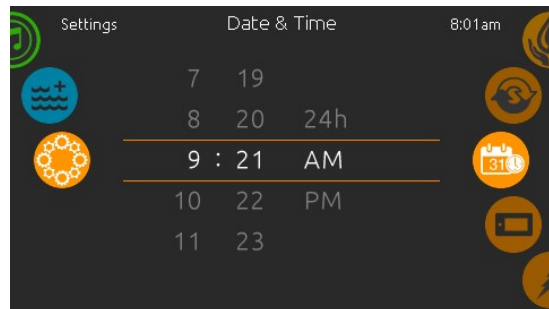
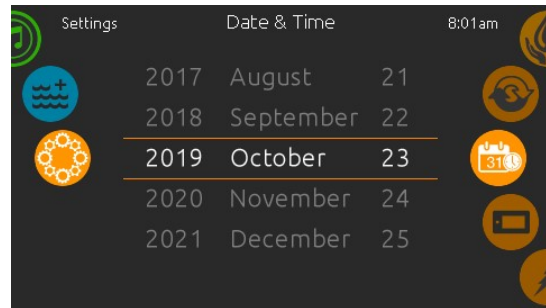

### KEYPAD SETTINGS

In this section you can change the temperature unit and language. Use the arrow keys and move to the setting that you would like to change. Use the Light key to choose and the arrow keys to modify

For the temperature setting you have a choice between Fahrenheit or Celsius.

For the language setting you have a choice between English and French.

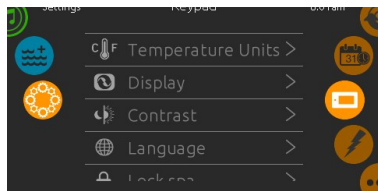

### ELECTRICAL CONFIGURATION

**Please do not make changes in this section unless you are a qualified electrician.**

#### ABOUT

This section shows information about the keypad software number and the revision numbers of the different components of your system.

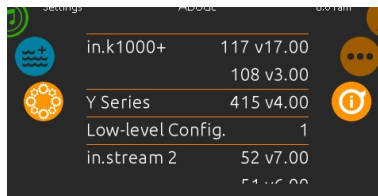

### PURGE CYCLES

The purge cycles are programmed to begin at the start of each filter cycle. Pump 2 activates for 1 minute, shuts off and then Pump 1 activates for 1 minute then shuts off.

### SMART WINTER MODE

Smart Winter Mode protects your system from the cold by turning the pumps on several times a day to prevent water from freezing in the pipes. The Smart Winter Mode indicator turns on when in this mode of operation. If the temperature drops to 4°C (39°F) within the heater chamber, the system automatically activates the pump to provide freeze protection. The pump will operate until the temperature reaches 5°C (41°F) before returning to normal system mode.

### COOLING DOWN

After heating the spa water to the desired set point, the heater is turned off, but the filtration pump remains on for a certain amount of time to ensure adequate cooling of the heating element in order to prolong the useful life of the heater. “Cooling to XX”F (“C)” message will appear at the bottom of the screen.

## OPTIONAL I-COMMAND 2 SYSTEM

The Smart Phone App that is designed as a wireless hot tub control which allows you to pick the water care settings that fit your schedule. Adjust filtration and temperature settings and create the ideal hot tub experience from inside your home. This option is supported by your iPhone®, iPod touch®, iPad® (requires iOS 8.0 or later) and Android Device (requires Android 2.3.3 and up).

**I-Command 2** (In. touch 2) comes with a state-of-the-art app and 2 pre-paired radio frequency transmitters:

One being part of the spa system and the second one, being connected to the Home Internet router. Both RF transmitters are pre-linked to one another, enabling an immediate and perfect communication between user and the spa.

### 1. Installing the home transmitter

The home transmitter is provided with an Ethernet cable and a power supply.

The in. touch 2 home transmitter unit must be installed inside the house, connected to a router and powered by the provided wall transformer. A longer Ethernet cable may be used to bring the home transmitter closer to the spa.

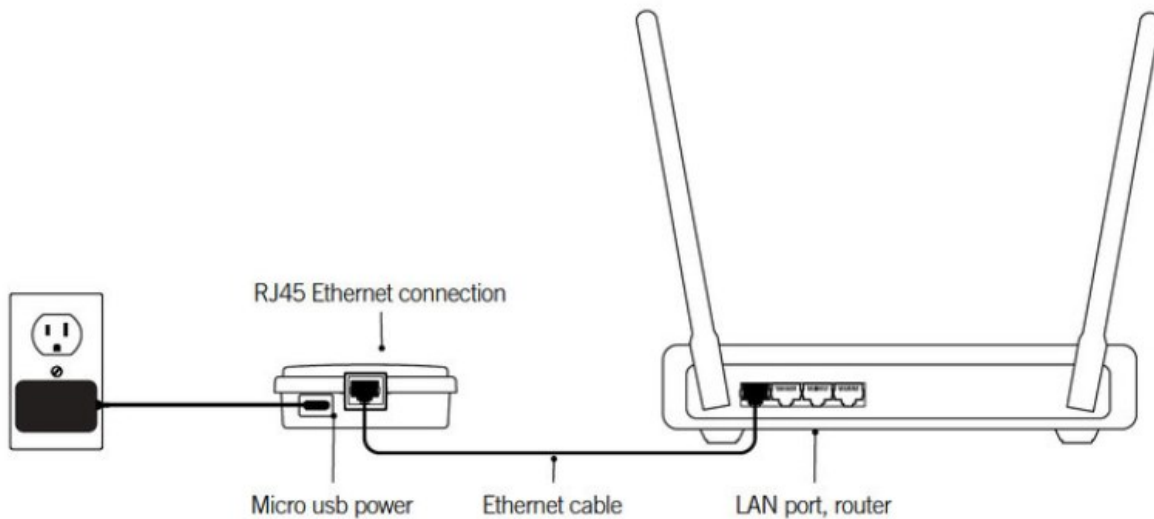

Simply connect the Ethernet cable into the RJ45 port of the in. touch 2 home transmitter and in one of the available LAN ports on your router. To power up the home transmitter, plug the provided wall outlet charger to a 120V (North American model) or 220V (European model) household supply and connect the USB cable to the wall outlet and the home transmitter.

## 2. Installing the spa transmitter

If you purchased a spa with in. touch 2 as a standard feature or as an option, note that the spa transmitter will be pre-installed.

To ensure proper signal transmission, it may be necessary to change the position of the transmitter once the spa is installed in the yard. The transmitter should be located on the side of the spa facing the house.

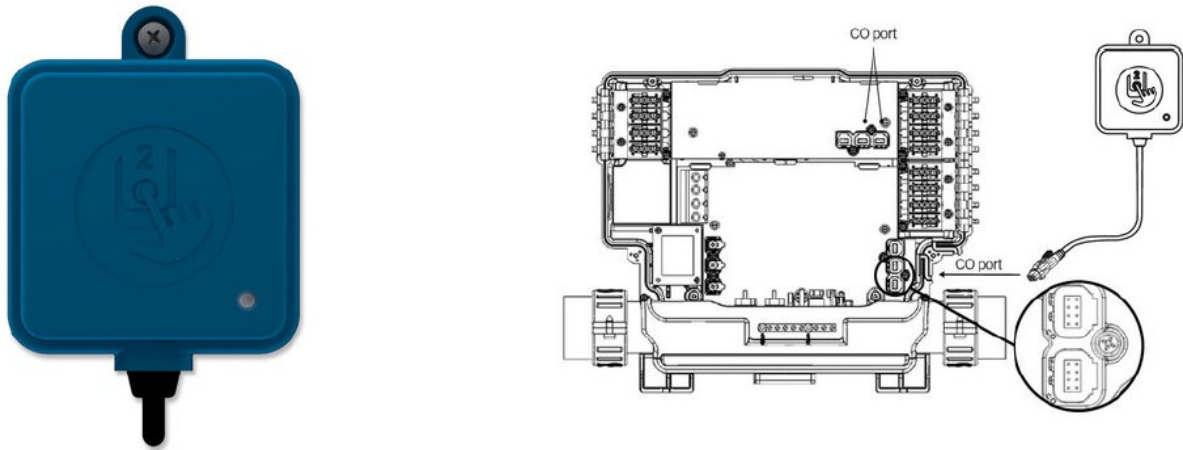

The in. touch 2 spa transmitter must be installed under the spa skirt, at least 12" (30 cm) away from any metal component or structure, as close as possible to the house to optimize the signal strength.

Simply connect the spa transmitter into an available CO port of the spa control system (or any other accessory with a free CO port, such as the in. stream 2 audio amplifier, or the in. clear water sanitization system).

## 3. Pairing the home and spa transmitters

If you bought an in. touch 2 equipped spa or a complete retrofit kit, both transmitters of your in. touch 2 will be factory pre-paired.

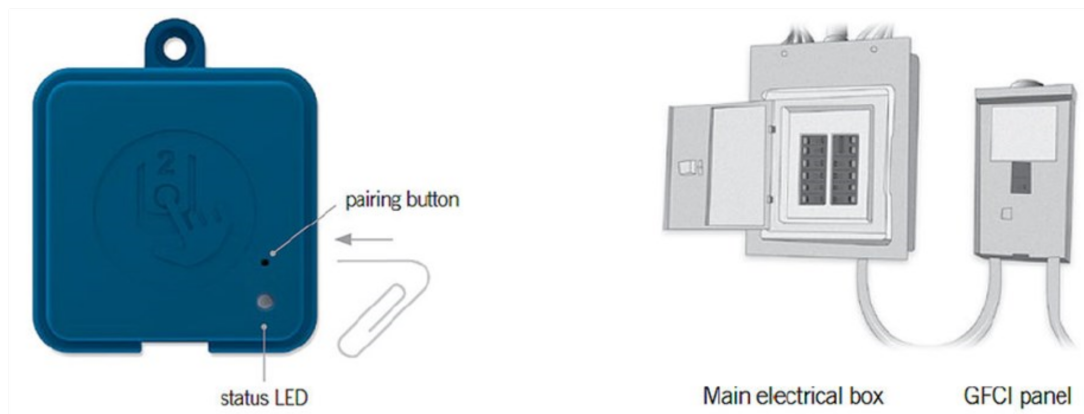

If you need to replace a transmitter or pair your transmitters again, power up the home transmitter and press on its pairing button with a paper clip. The status light of the transmitter will blink yellow.

Then, shut off the spa’s breaker to turn the spa transmitter off. Wait a little and put the breaker back on. Within a few seconds, pairing will be completed and both transmitter status lights will turn to blue.

#### 4. Transmitters status LED indicator

Both the home and spa transmitters have color status LED that can be used for troubleshooting purposes

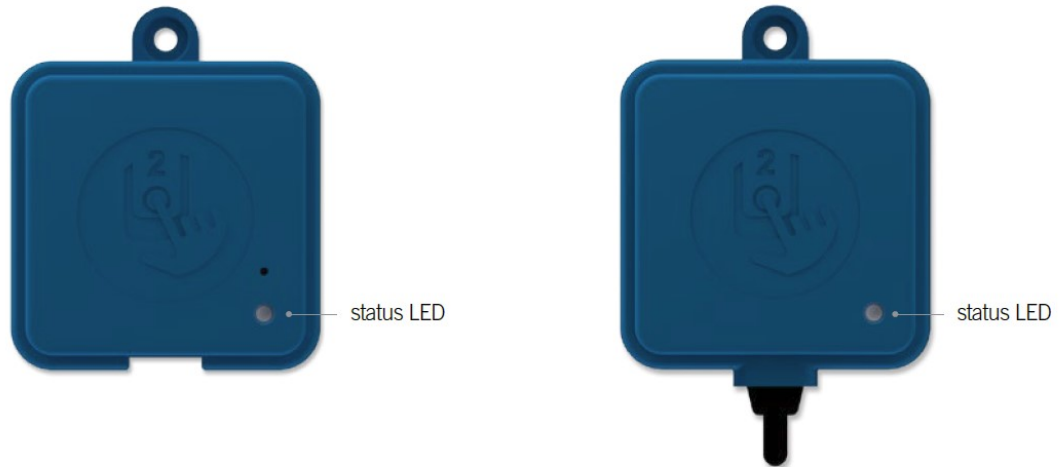

##### Home Transmitter

Pairing mode	<span style="color: yellow;">●</span>	Yellow (Blinking)
Router not detected	<span style="color: red;">●</span>	Red
Router detected	<span style="color: green;">●</span>	Green
in.touch 2 server detected Module is fully functional	<span style="color: blue;">●</span>	Blue

##### Spa Transmitter

Pairing mode	<span style="color: yellow;">●</span>	Yellow (Blinking)
Spa controller not detected	<span style="color: red;">●</span>	Red
in.touch 2 server detected Module is fully functional	<span style="color: blue;">●</span>	Blue

***When the LED status is blinking (blue, green or red) this indicates that the communication between the EN module and the CO module it not established.***

## 5. Strong and Long Range Communication Signal

Through their proprietary RF technology, in. touch 2 transmitters emit a strong, stable and long-range signal between your spa and your router (about 3 times longer than regular signal). No need for repeaters or boosters: your spa will always remain within reach in typical backyard settings.

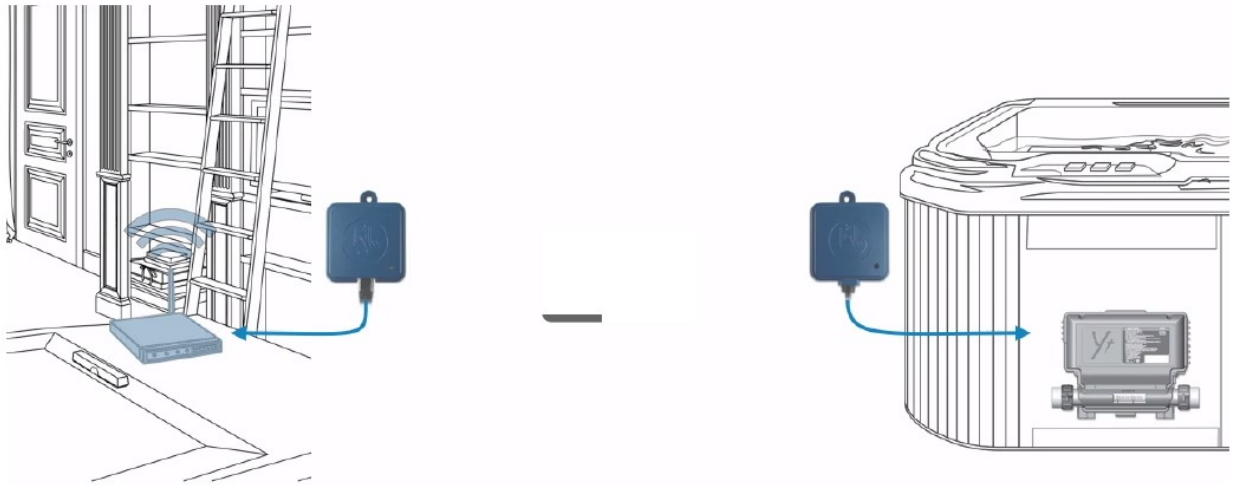

## 6. Application

Download application:



The in. touch app allows you to control your spa using your home network or an Internet connection anywhere in the world. The in. touch 2 app is waiting for you in the App Store for iOS devices and on Google Play for Android — search for « in. touch 2 » then click on it to install.

## USING THE APP

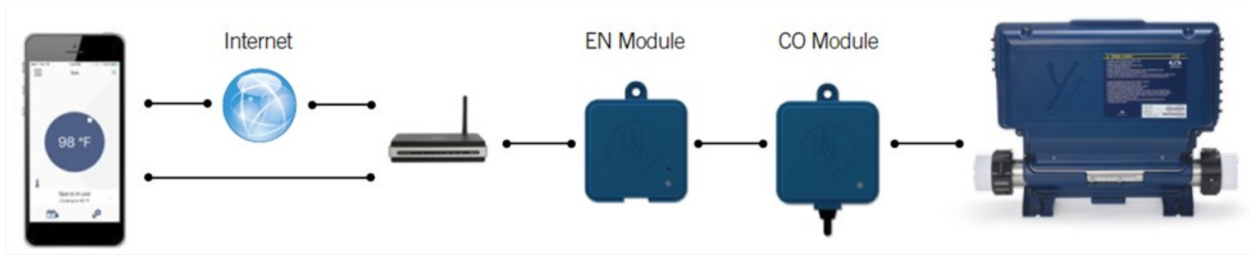

### On your home network

It is possible to access your spa with the in. touch 2 app through your home network. To be able to see your in. touch 2 in the application you need to connect your device to the same router (Wi-Fi network) than the one used to connect your Home Transmitter

Go to the Wi-Fi settings section of your mobile device and choose the same network that your spa is connected to (i.e. Home). Once you've selected it, wait until your device confirms the connection.

### On the Internet

The in. touch 2 allows you to use the Internet to control your spa from anywhere in the world. In order for them to communicate, both the in. touch 2 module and your device must be connected to a network that allows access to the Internet.

Once your Home Transmitter is connected to the Internet (the LED status is blue), you can use your in. touch 2 app any time your device is also connected to the Internet (wireless or cellular network), even if you are away from home.

To have access to your spa away from home, you will need to have previously linked your mobile device to your spa on your home network.

## Setup your Wi-Fi on your device

Before using your application, go to the Wi-Fi section of your device's settings. Make sure you are connected to your home network. This needs to be the same Wi-Fi provided by the router to which you connected your Home Transmitter.

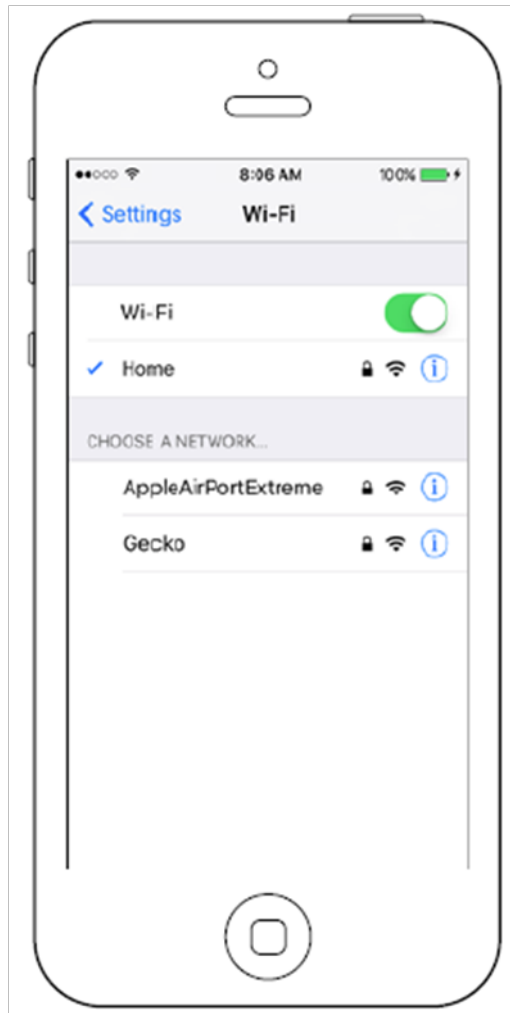





Find the icon for the in. touch 2 application, then tap on it to open it.

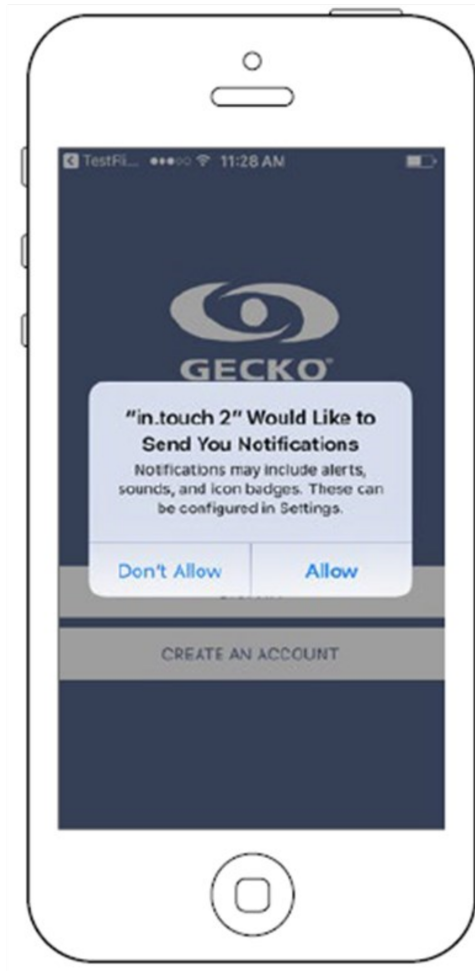

The first time you use the application a message will ask you: "in. touch 2" Would like to send you notifications. If you choose *Allow*, the application will send you notifications about the status of your spa. If you choose *Don't Allow*, the application will not send you notifications.

## Login page

Before using your application, you must create an account first and then, you'll be able to sign in. Your account will give you the opportunity to have access to your spa from any in. touch 2 application.



## New account creation

When you choose to create a new account, you agree at the same time the Terms of Service and the Privacy Policy. You can read them at any time through this link:

<https://geckointouch.com/legal>

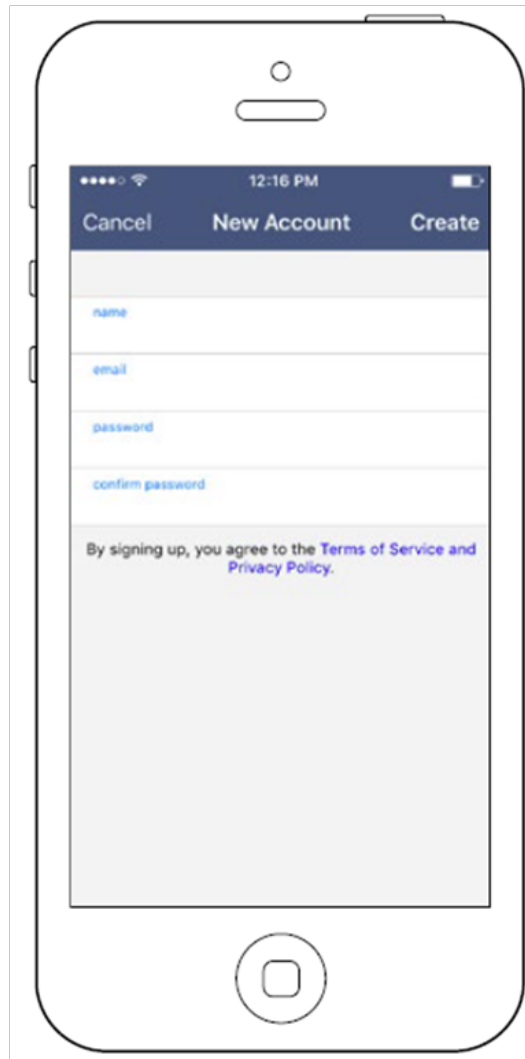

## Choose a spa



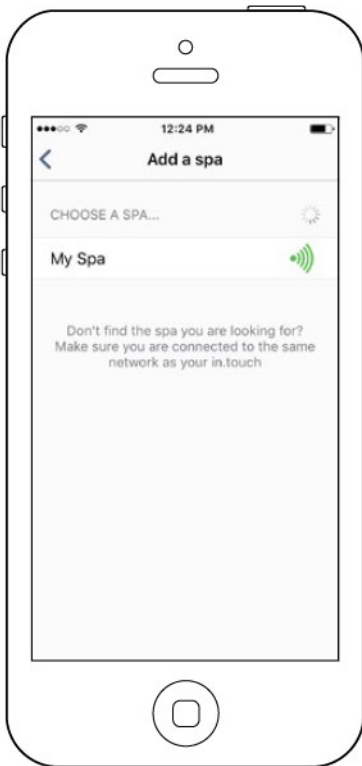

This page displays all the spas detected by your application.  
To detect your spa, you need to connect your mobile device to the same network to which you connected your Home Transmitter.

Once you have done a connection with the spa its name will be saved on this page to allow you to connect to this spa from anywhere.

To add a spa later on, go to Settings (up right corner) - Add a spa



The RF signal strength (communication between the two in.touch 2 transmitters) is illustrated on the Select a spa page. There are 5 possible states:

-  • Signal superior to 80%
-  • Signal between 80% and 51%
-  • Signal between 50% and 31%
-  • Signal below 30%
-  • The Spa Transmitter is not available

## Home page

The main screen gives you access to your accessories, water temperature, water care and settings.

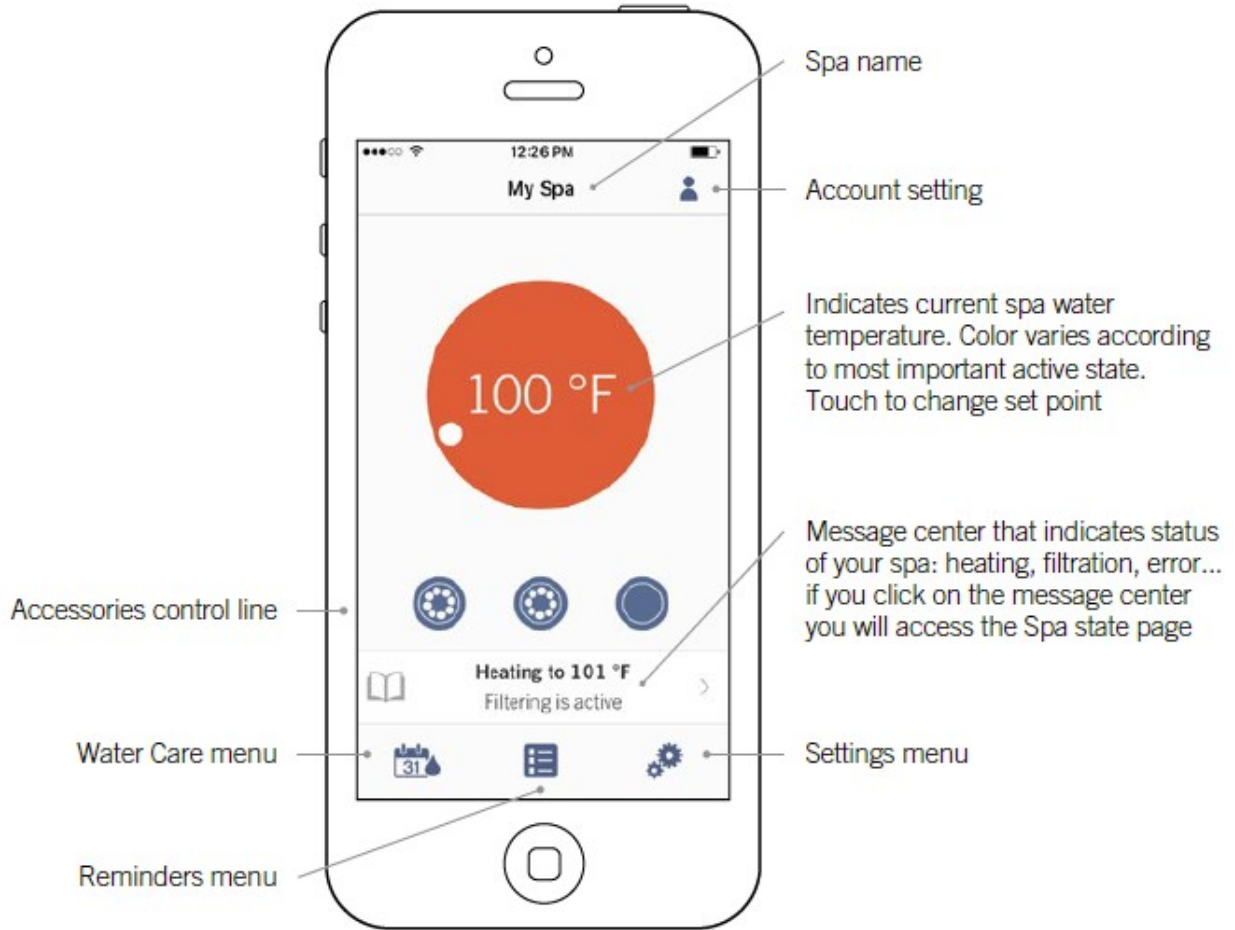

**The app is mirroring the top side control (keypad) over the internet.**

## STANDBY MODE



A press of the **SETTINGS** icon and scroll to the **MAINTENANCE** menu options. Press the **MAINTENANCE** icon to display the **STANDBY** icon. Press the **STANDBY** icon and the following message will appear.

**“All pumps off! Press Cancel to exit Standby mode or Drain to drain spa”**

This mode allows you to stop all outputs including all automatic functions such as a filter cycle, heating requests and smart winter mode purging for 30 minutes to perform quick spa maintenance.

## DRAIN MODE

If you wish to put your spa into **“DRAIN MODE”** follow the instructions above for putting the spa into **“STANDBY MODE”** and then press **DRAIN** on the display. Once you do that the display will indicate **“Drain in progress”**. The filtration pump will turn on and run for 60 minutes.

In order to exit this mode, press **CANCEL** to exit **DRAIN MODE**. This will put you back into **STANDBY MODE** and if you wish to exit that press the same key to go back to the main screen.



## TOPSIDE PANEL DISPLAY MESSAGES

**Hr** - An internal hardware error has been detected

**Prr** - The Prr error message indicates a problem with the regulation probe. The system is constantly verifying if the temperature probe reading is within its normal limits.

**HL** - The water temperature at the heater has reached 119°F (48°C). **Do not enter spa water.**

**FLO** - The system did not detect any water flow while the filtration pump was running.

**UPL** - No low level configuration software has been downloaded into the system.

**AOH** - The temperature inside the spa skirt is too high, causing the internal temperature in the spa pack to increase above the normal limits.

**OH** - The water temperature in the spa has reached 108°F (42°C). **Do not enter spa water.**

## OPTIONAL VARIABLE AIR THERAPYSYSTEM CONTROL FUNCTIONS:

**Press:** Blower button on main control to activate system.

### 1) ON/OFF :

**1<sup>st</sup> Press:** The Blower starts at maximum Speed. LED: ON

**2<sup>nd</sup> Press:** The blower stops. LED: OFF

### 2) TO CONTROL SPEED:

**Press and hold:** Speed goes up or down, LED: ON when pressing.  
Release pressure at the desired speed.

### 3) TO CONTROL PULSATION:

**1<sup>st</sup> Press:** Slow Pulsation Cycle, LED: ON.

**2<sup>nd</sup> Press:** Quick Pulsation Cycle, LED: Flashes.

**3<sup>rd</sup> Press:** Pulsation Cycle OFF, LED: OFF.



## BELLAGIO CONTROL FILTER

This filter must be cleaned at each drain and refill of your swim spa to ensure proper functionality of the Bellagio Waterfalls. It is located behind the door in the equipment area. To access the filter screen turn large canister section of the assembly counter-clockwise till the apparatus separates revealing screen filter. Run filter under tap to clean out any debris and reassemble in reverse order.



### ADJUSTABLE FLOW CONTROL

Your Hydropool swim spa is equipped with 1 DIVERTER valve to control and adjust water flow to suit individual user preference. The pump 1 (P1) DIVERTER valve provides variable water flow adjustment between the lower centre swim jet (providing added buoyancy and variable swim resistance), and the hydrotherapy jets on the bucket seats, or a combination of both.

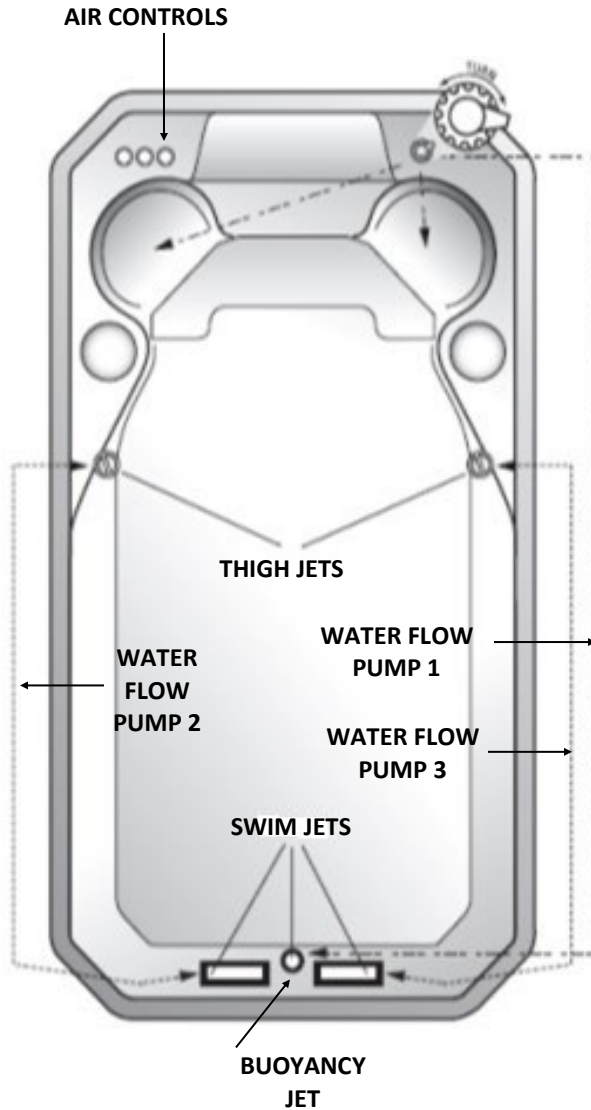

### AQUAPRO AX CURRENT CONTROL (Aquatrainers only)

This system allows for the swimmer to vary the flow of water and adjust the swim intensity of the jets. Allows quick adjustment to level of fitness the swimmer is accustomed to from Novice to Triathlete. This option has a keypad near the swim end so that they can easily adjust their swim without having to go back to the main keypad area and eliminates the need for manual diverters.

**NOTE: You should always start from a full on or full off position to ensure you have consistent water flow. Failure to do so may unbalance the system requiring it to be recalibrated.**

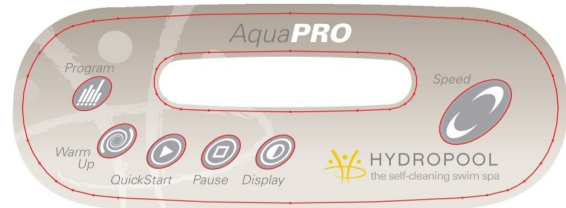

### AQUAPRO SELF-CALIBRATION PROCEDURE

1. After you manually set up the cam positions, you must set up the programming ensuring that the communication cables coming out of the DJS-5 black box are directed to the main and auxiliary packs respectively.
2. Press the **PROGRAM** key for 30 seconds or until the display shows "F50H" or "F60H".
3. If the swim spa is for North American use select "F60H" by using the up and down arrows on the keypad. If the swim spa is for European use select "F50H".
4. Press the **PROGRAM** key again and the display will show "SET1". Press the **PROGRAM** key again and the controller will go through a learning mode to ensure that the cams have been set up properly.
5. If the cams have not been set up properly you will get an "ERR" code and possibly a service wrench on the side display.
6. In that case one of the actuators is defective and needs to be calibrated or replaced.

Contact your local retailer for service.

## AQUAPRO EX CURRENT CONTROL SYSTEM

HydroPool's Executive Trainer Swim Spas are equipped exclusively with a fully programmable VFX Control that has four user programs and four preset programs, giving the user the ability to dial in the perfect swim. The patented V-Twin jets deliver the smoothest and most predictable swim current in the industry.

### CONTROL / QUICK OVERVIEW

The AquaPro EX Control gives you the ability to simultaneously adjust the speed of both V-Twin jets from 0 - 6.56 kph (0 - 4.07 mph) and can be adjusted for anyone from a novice level to a triathlete. This is the first swim spa with built-in treadmill technology that can track your speed, distance, time training and calories burned.



**Figure 1: Main screen with pumps off**

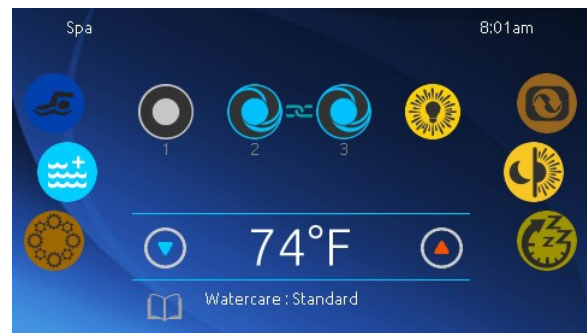

**Figure 2: Main screen with pumps on**

### BEGINNING YOUR SWIM EXPERIENCE

By pressing the “swimmer” icon on the top left of the screen you will enter the submenu system that allows you to scroll through the following settings:

1. Training Drills
2. Swim Settings
3. User Settings
4. Swim Statistics

## AQUAPRO EX CURRENT CONTROL SYSTEM (continued)

### TRAINING DRILLS / PROGRAM SELECTION

When you enter the submenu system and select the “Training Drills” icon you can select the following programs to run for your swim experience.

1. **ENDURANCE PROGRAM** - If you choose Endurance the swimming workout will be executed at a constant intensity for the entire duration.
2. **LAP PROGRAM** - If you choose Lap, this training drill will perform high and low intensity intervals of equal step time.
3. **TRANSITION PROGRAM** - If you choose Transition, this training drill will perform a series of equal steps at random intensities.
4. **CARDIO PROGRAM** - If you choose Cardio, this training drill will perform two successive steps at high intensity for one step at low intensity.
5. **POWER PROGRAM** - If you choose Power, this training drill will perform a pyramid program where the intensity will progressively increase until a maximum intensity level is reached. It will then decrease progressively to end at low intensity.
6. **PERSONALIZED PROGRAMS** - You can select from three personalized programs where you can enter the duration of the workout you want as well as the units of measure (International / Metric).

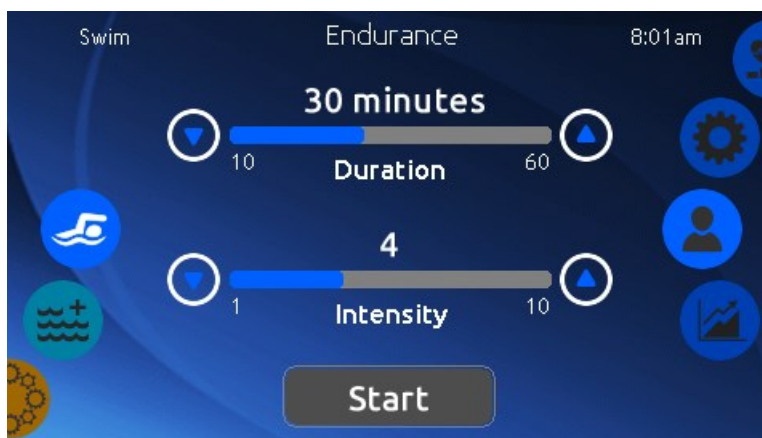

## AQUAPRO EX CURRENT CONTROL SYSTEM (continued)

### SWIM SETTINGS SELECTION

When you enter the submenu system and select the “Swim Settings” icon you can select the following settings.

1. WARM UP
2. COOLDOWN
3. STEP TIME
4. PREPARATION TIME

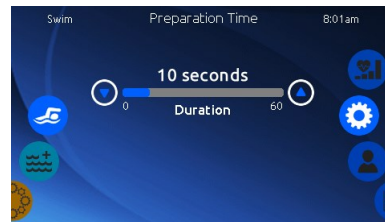
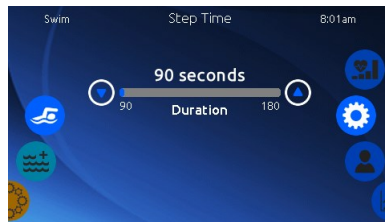
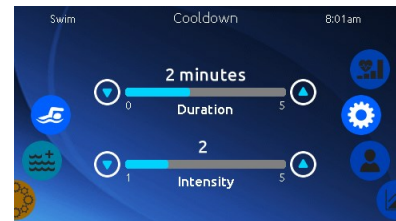
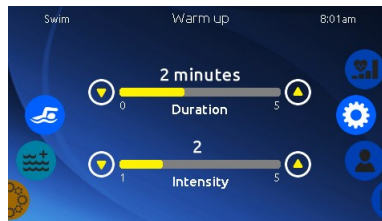

### USER SETTINGS SELECTION

When you enter the submenu system and select the “User Settings” icon you can select one of the unused “User Names” and enter your name and weight depending on which unit of measure you selected from the swim settings menu.

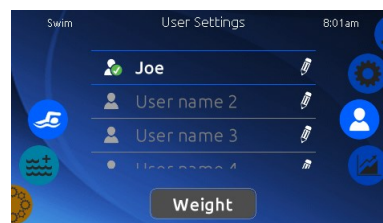
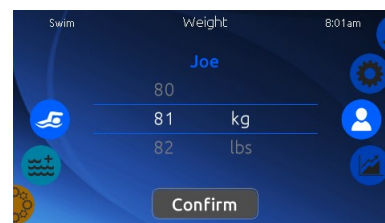
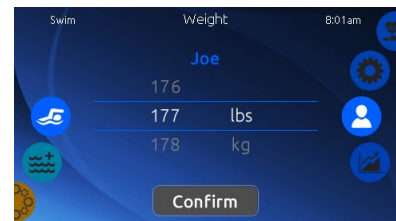
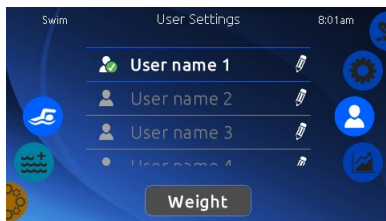

## AQUAPRO EX CURRENT CONTROL SYSTEM (continued)

### SWIM STATISTICS SELECTION

When you enter the submenu system and select the “Swim Statistics” icon it will indicate the calories burned, distance achieved in either miles or kilometers depending on the unit of measure you selected from the swim settings menu and the elapsed time.

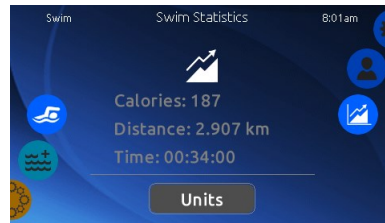
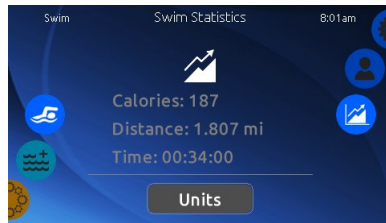



## HYDROCLEAR PUREWATER SYSTEM

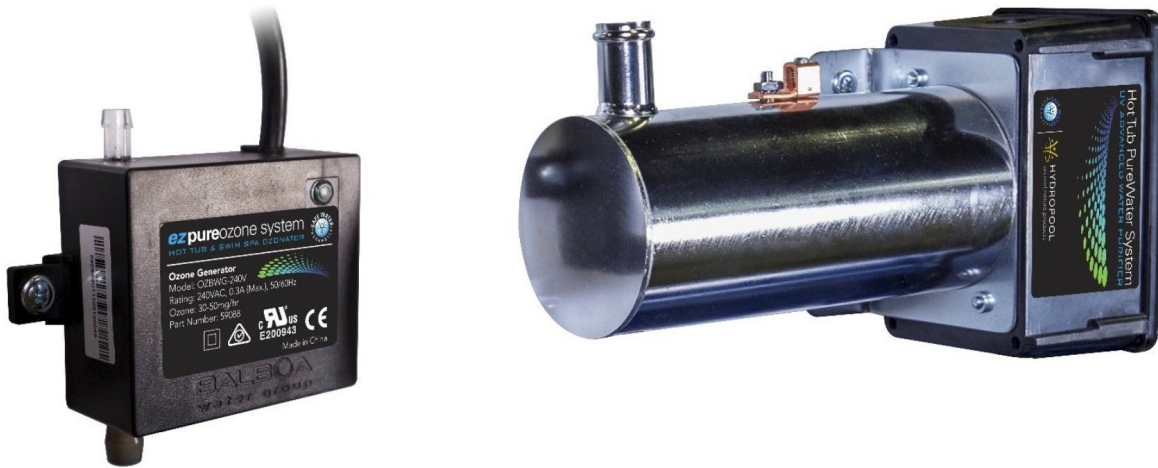

### HOW IT WORKS

This system combines the benefits of both Ozone and UV-C creates powerful hydroxyl radicals to burn off contaminants and dissolved solids within the water to significantly increase the clarity of the spa water. The UV-C rays also breakdown chloramines which are the main cause of respiratory, eye and skin irritation typically associated with chlorine. Harmful/corrosive off gassing is also dramatically reduced through this process.

### MAINTENANCE AND SERVICE

While operating, check regularly to see if bubbles are entering the spa.

After 10,000 hours the UV LED will begin flashing yellow indicating its time to replace the UV-C lamp.

Replace the check valve assembly annually to ensure continued optimal performance from the Hydroclear Pure Water System.

To replace the UV-C lamp or check valve please go to [www.balboawatergroup.com/UVSanitizer](http://www.balboawatergroup.com/UVSanitizer) for the procedure on how to do this.

### IMPORTANT

**YOU MUST CONTINUE TO CHECK YOUR WATER CHEMISTRY REGULARLY AND SANITIZING CHEMICALS WILL BE NECESSARY TO TREAT THE WATER. CONSULT YOUR SPA PROFESSIONAL FOR FURTHER ADVICE.**

## HYDROCLEAR PUREWATER SYSTEM (continued)

### UV-C LAMP REPLACEMENT INSTRUCTIONS

**Important:** It is mandatory that the UV-C lamp is replaced every 12 months to maintain optimum performance.

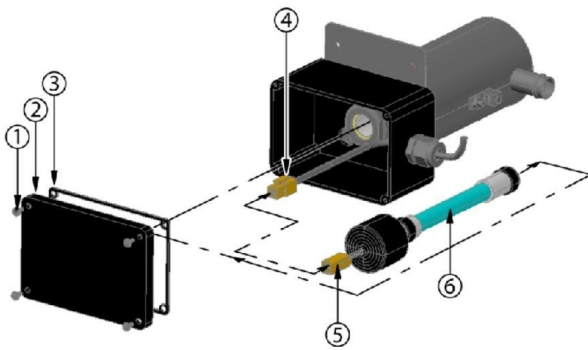

KEY	DESCRIPTION
1	SCREW
2	ENCLOSURE COVER
3	ENCLOSURE GASKET
4	BALLAST CONNECTOR
5	UV-C LAMP CONNECTOR
6	UV-C LAMP

**NOTE:** Your UV System unit may look different than shown in the picture



# DANGER

- Turn the spa breaker to the OFF position.
- Allow the UV-C lamp (6) to cool down prior to removing it from the UV system.
- Never look at the lit UV-C lamp (6). This can cause severe eye damage or blindness.

### INSTRUCTIONS:

1. Remove the UV system enclosure cover (2) by removing 4 Phillips screws (1). Keep the gasket (3) together with the enclosure cover (2) for later use.
2. Make sure to use latex glove when handling the UV-C lamp (6).
3. Slowly disconnect the old UV-C lamp connector (5) from the ballast connector (4).
4. Slowly remove the old UV-C lamp (6) from the UV unit.
5. Slide the new UV-C lamp (6) into the UV unit.
6. Reconnect the new UV-C lamp connector (5) to the ballast connector (4). Make sure the connectors mate completely. Do not force.
7. Reinstall the enclosure cover (2) with the gasket (3) and secure with screws (1).
8. Reconnect the unit to the spa controller and reinstall the spa controller's cover.
9. Turn on the power to the spa.
10. Once power is activated you can check the ballast to see if the unit is functioning. A solid green light indicates the unit is being provided power and should always be on. A solid red light indicates that the UV-C lamp is activated.



# WARNING

The UV-C lamp used in this unit contains mercury. Properly dispose of the old UV-C lamp in accordance with disposal laws. See [www.lamprecycle.org](http://www.lamprecycle.org).

## SWIM SPA WATER BALANCE – GENERAL OVERVIEW

### NOTABLE POINTS

- The reliability and longevity of your swim spa support equipment are directly related to how well water quality is maintained!
- The small volume of water in your swim spa is easily affected by the introduction of oils, lotions, perspiration and chemicals. It is imperative that you give your swim spa regular attention to maintain clean, and balanced water to prevent premature damage and/or failure (corrosion/calcification) to the support equipment. Maintaining proper swim spa water balance and sanitizer levels is extremely important. Neglected hot water will allow bacteria to quickly spread.
- The mineral content of swim spa water increases due to water evaporation, sanitizers and other chemicals. If the mineral concentration, particularly calcium, becomes too high, the minerals will literally “drop” or precipitate out of the water and deposit on the swim spa walls, plumbing, jets, in the filter and on the heater element.
- It is very important that pH be checked frequently and maintained in the recommended range as indicated in the chart **WATER BALANCE SUMMARY FOR YOUR SWIM SPA**
- It is also very important that Total Alkalinity (the ability of the water to resist a change in pH) be maintained in the recommended range as indicated in the chart **WATER BALANCE SUMMARY FOR YOUR SWIM SPA**
- Although there may be two identical swim spa models right next door to each other, the maintenance requirements will be different, dependant on such factors as:
  - bather load
  - frequency of use/quantity of bathers
  - different body chemistry
  - sun vs. shade
  - temperature

For these reasons, it is very important to develop proper swim spa water maintenance habits and follow your HydroPool retailer’s recommended water maintenance procedures.



**Heater and other component failure due to improper water balance is not covered under warranty.**

Your HydroPool swim spa comes with a built in bromine/chlorine dispenser, (located in the lid of the cartridge filter housing), refer to section **CARTRIDGE FILTER** for details on removing and re-installing the lid. Once the filter lid is removed, you’ll notice a clear 2.5 cm (1”) diameter tube extending from the bottom of the lid.



## WARNING

### CHEMICAL HANDLING SAFETY HINTS

- **Never pre-mix chemicals with each other prior to adding to hot tub water.**
- **Add only one chemical to the water at a time.**
- **Always add chemicals to water and not vice-versa.**
- **Chemicals may be corrosive, so handle with care and store in a cool dark place.**
- **Never smoke near chemicals as most are flammable**
- **Ensure any spilled chemicals are carefully cleaned up immediately.**
- **Always have the POISON CONTROL telephone number handy in the event of an emergency.**
- **Keep chemicals out of children’s reach**
- **Wear safety glasses and gloves when handling chemicals.**

### INITIAL WATER FILL & BALANCE

- 1 Make sure the swim spa is circulating.
- 2 Add a sequesterant (stain and scale controller). Allow water to circulate for an hour before adding anything else to the swim spa water.
- 3 Add a Shock / oxidizing agent .
- 4 Add sanitizing tablets (Bromine or Chlorine) to the dispenser:

DISPENSER

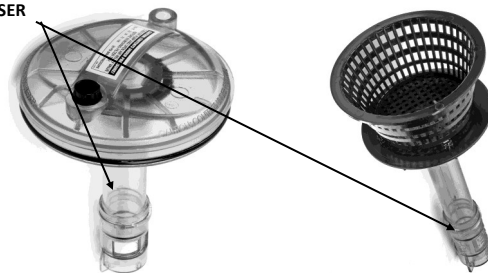

Expose the large Refill hole at the end of the tube and add 5 or 6 tablets. Do not overfill dispenser as performance will be affected. Turn to expose the largest area and allow water to circulate for 3 or 4 hours before testing level. Adjust to lesser area as necessary to maintain a level of **3 –5 PPM** Sanitizer.

Floating dispenser: As above, add 6 or 7 tablets, adjust initially to ‘5’, allow water to circulate for 3 to 4 hours, then test.

The tablets will dissolve slowly over a 10-14 day period, depending on setting, and use of the hot tub.

**5** Test pH and Total Alkalinity and also adjust accordingly.

Expose the large Refill hole at the end of the tube and add 5 or 6 tablets.

Do not overfill dispenser as performance will be affected. Turn to expose the largest area and allow water to circulate for 3 to 4 hours before testing level. Adjust to lesser area as necessary to maintain a level of **3-5 PPM** Sanitizer.

## GLOSSARY OF COMMON WATER MAINTENANCE TERMS

- 1 **CHLORINE** – in granular, liquid or puck/tablet form, is an oxidant and biocidal agent. It is very effective and fast acting. Recommended chlorine residual level is 3.0 to 5.0 ppm.
- 2 **CHLORAMINES** – a compound formed when chlorine combines with nitrogen or ammonia present in the water. When allowed to go unchecked, it causes eye and skin irritation and is indicated by a strong chlorine odor.
- 3 **ONE-PART BROMINE** – also available in puck/tablet form, is another type of oxidant/biocidal agent, and is introduced into the hot tub water via a brominator. Recommended bromine residual level is 3.0 to 5.0 ppm
- 4 **TWO-PART BROMINE** – composed of a liquid or powder component introduced manually into the water on a weekly basis, and a granular component that is added daily or as the hot tub is used.
- 5 **BROMAMINES** – are formed when bromine destroys nitrogen-bearing organic matter. Unlike chloramines, bromamines don't cause eye irritation, however, when allowed to go unchecked, will cause an objectionable odour.
- 6 **SHOCK** – the practice of adding an oxidizing agent to hot tub water to destroy ammonia, nitrogenous and organic contaminants (chloramines and bromamines)
- 7 **pH** – a logarithmic value expressing the relative acidity or basicity of a substance (such as hot tub water) as indicated by the hydrogen ion concentration. pH is expressed as a number on a scale of 0 to 14, where 0 is most acidic, 1 to 7 being acidic, 7 considered neutral, 7 to 14 being basic, and 14 being most basic. The ideal range for hot tub water is 7.4 to 7.6 ppm
- 8 **pH INCREASER** – raises the pH level of the water.
- 9 **pH DECREASER** – lowers the pH level of the water.
- 10 **TOTAL ALKALINITY (TA)** – the amount of carbonate, bicarbonate and hydroxide compounds present in the water that determines the ability or capacity of the water to resist change in pH. Also known as the 'buffering' capacity.
- 11 **ALKALINITY BOOSTER** – raises the alkalinity.
- 12 **CALCIUM HARDNESS** – the calcium portion of the total alkalinity which represents 70 to 75% of total hardness. Calcium concentrations determine whether water is 'soft' - too little calcium, or 'hard' -too much calcium.
- 13 **CALCIUM BOOSTER** – increases the calcium level.
- 14 **TOTAL DISSOLVED SOLIDS (TDS)** – a measure of the total amount of dissolved matter in the water (calcium, carbonates, bicarbonates, magnesium, metallic compounds, etc.)
- 15 **SEQUESTERANTS (STAIN AND SCALE CONTROLLERS)** – keeps dissolved metals and minerals in the water from attacking the hot tub shell and support equipment components.
- 16 **DEFOAMER** – removes foam build-up from the water surface. At best, this is a temporary remedy, as excessive foam is merely a symptom of improper water balance (typically high organic residue and/or high pH).
- 17 **CARTRIDGE FILTER CLEANER** – degreases and cleans cartridge filters.
- 18 **OZONATOR** – generates Ozone (a gaseous molecule composed of 3 atoms of oxygen) and is injected into the hot tub water for the oxidation of water contaminants.
- 19 **TEST KIT** – used to monitor specific chemical residual or demands in the water. May be in the form of litmus strips or liquid drops.
- 20 **PPM** – abbreviation for 'parts per million', the unit of measurement used in chemical testing which indicates the parts by weight in relation to one million parts by weight of water. Essentially identical to the term mg/L - milligrams per liter.

### WATER BALANCE SUMMARY FOR YOUR SWIM SPA\*

SANITIZER (ppm)	MIN	IDEAL	MAX
Chlorine	1.0	3.0 - 5.0	5.0
Bromine	1.0	3.0 - 5.0	5.0
<b>CHEMICAL</b>			
PH	7.2	7.4 - 7.6	7.8
Total Alkalinity (TA)	80	80 - 120	180
Calcium Hardness	150	200 -400	500 -1000

\*National Spa & Pool Institute recommended levels for residential spas/hot tubs

## WATER BALANCE TROUBLESHOOTING

PROBLEM	POSSIBLE CAUSES	SOLUTIONS
Cloudy Water	Microscopic particles too small to filter out.	Test and adjust all water balance elements and add flocculent* to cause the particles to combine together so they can be filtered out. Increase filter cycle time.
High Total Alkalinity High pH levels High Calcium Hardness		Test these water balance elements and adjust to recommended parameters.
Scale (White/Grayish Deposit)	High Calcium Hardness	Test calcium hardness level and treat with sequestering agent* or perform partial drain/refill.
Skin Eye Irritation	Improper pH and/or Total Alkalinity levels	Test water balance and make the appropriate changes.
Excessive Foam	Buildup of body oils or cosmetics	If no water line is present you can try using defoamer* to break up the contaminants and then a clarifier* to help filter them away. If a water line is present the spa may need to be drained and cleaned. Either way, the filter should be thoroughly cleaned by soaking overnight in bleach. An oil absorbing sponge can help in preventing this in the future. Increase filter cycle time.
	Laundry detergent residual in swimwear	Prevent by running an extra rinse cycle on washing machine or re-rinse well by hand
	Excess organic contaminants	Some organic matter is prone to causing foamy water as it breaks down in the filter (maple leaves especially). Generally using defoamer* to break up the contaminants, then a clarifier*  To help filter them away followed by thoroughly cleaning your filter will clear up the problem. It may however be necessary to drain and refill your spa if the foaming is quite excessive.
	Low Calcium Hardness	Test calcium hardness and if necessary increase with calciumchloride*
Corrosion/Etching	Presence of metals in water (iron, copper, etc)	Test total alkalinity levels and if necessary increase with sodium bicarbonate*
Discoloured Water (Clear v. turbid water)	Presence of metals in water (iron, copper, etc)	Treat with chelating* or sequestering agent*
Unstable pH	Low Total Alkalinity levels	Test total alkalinity levels and if necessary increase with sodium bicarbonate*
pH resistant to changing	High Total Alkalinity levels	Test total alkalinity levels and if necessary decrease with sodium bisulfate* or muriatic acid*
		* Contact your local Hydropool retailer for specific product recommendation



## ROUTINE SWIM SPA MAINTENANCE



### REVIEW CHEMICAL HANDLING SAFETY HINTS

#### DAILY

- 1 Test water, and if necessary, add shock.
- 2 Ensure proper water level is maintained.

#### WEEKLY

- 1 Test pH and Alkalinity. Adjust accordingly
- 2 Top-up chemical dispenser
- 3 Add sequesterant (**stain and scale controller**)
- 4 Remove and spray cartridge filter with garden hose and re-install (**see section CARTRIDGE FILTER**)
- 5 Remove and clean out skimmer basket (**see section CLEANING THE SKIMMER BASKET**)
- 6 Add Shock / oxidizing agent
- 7 Inspect union connections for o-ring and gasket leaks - Tighten if loose
- 8 Clean stainless steel controls as indicated on page 29.

#### MONTHLY

Soak your filter cartridge in a filter cartridge cleaning solution. Rinse thoroughly and, if possible, allow to dry before re-installing. HydroPool recommends purchasing a second filter so that while the first is cleaning, the other is clean and ready to install

#### QUARTERLY

At least once per quarter, clean the acrylic shell surface with a non-abrasive cleaner designed specifically for acrylic surfaces.

#### SAFETY HARD COVER

When a hot tub is uncovered, over 90% of heat is lost from the water surface. This evaporation also affects the chemical balance and could create humidity problems indoors. HYDROPOOL Safety Hard Covers are engineered for maximum thermal efficiency and appearance. They are hinged in the middle for easier handling, and the zip fastener allows the tapered foam inserts to be changed if damaged. The skirt of the safety hard cover hugs the lip of the hot tub for a tight fit. The locks, with one part fastened to the deck or skirt, prevent small children or animals from entering the hot tub.

Do not drag the safety hard cover across the hot tub or decking. Standing on the hardcover could cause the tapered foam inserts to crack, which will lead to water absorption.

#### NEVER LEAN OR STAND ON YOUR HARDCOVER.

The cover should be cleaned at least twice a year with a vinyl moisturizer and protector.

**NOTE: ALWAYS ENSURE THE SAFETY HARDCOVER IS IN PLACE AND LOCKED WHENEVER THE HOT TUB IS NOT BEING USED. FAILURE TO DO SO MAY CAUSE DAMAGE OR CRACKING OF THE ACRYLIC SURFACE NOT COVERED UNDER THE WARRANTY.**

#### CLEANING THE SKIMMER BASKET

- 1 Activate the **STANDBY/DRAIN ASSIST** mode
- 2 Remove the skimmer basket by pulling the weir door forward, and pulling the basket up and towards the front
- 3 Remove debris from basket. (**Note: Avoid hitting the basket against objects to knock debris loose as this may damage the unit**)
- 4 Reinsert basket
- 5 Take the system out of **STANDBY/DRAIN ASSIST** mode, and as the pump begins to operate, monitor water flow over the weir door to assure that it is free floating

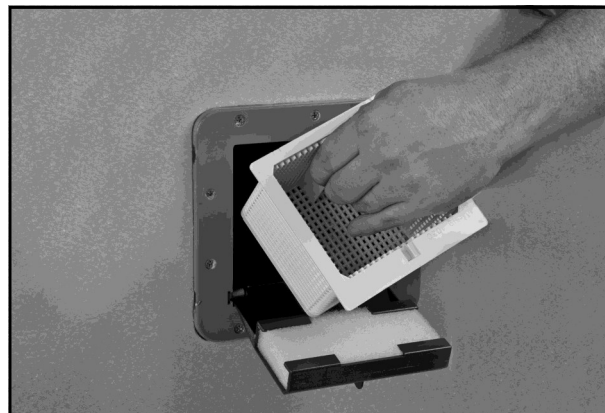
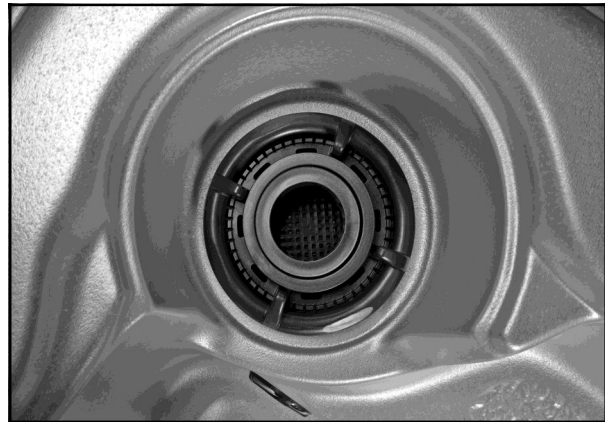



### CARTRIDGE FILTER

The cartridge should be cleaned every two to four weeks, depending on the amount of use. Signs that the filter requires cleaning include:

- **Reduced jet power**
- **Hazy gray water**
- **Rattling noise in the pump or filter**
- **Heater not working**

### REMOVAL

- 1 Activate the **STANDBY/DRAIN ASSIST** mode.
- 2 Remove the filter cover and open the small, black air vent / bleeder valve on the top of the filter lid.
- 3 Lift the Gray lock tab to disengage and turn the locking ring counter clockwise.
- 4 Pull the filter lid upwards, and lift the cartridge element straight up and out of filter housing.

### CLEANING

- 5 With a garden hose and spray nozzle, hose off the cartridge element, ensuring to carefully separate every pleat.
- 6 To remove collected lotions, body oils, etc. soak the cartridge in warm water and a filter cleaning/emulsifying compound (**available at your HYDROPOOL retailer**).
- 7 A cleaning cylinder may be purchased from your **HYDROPOOL** Retailer.
- 8 Rinse thoroughly and dry before replacing.
- 9 HydroPool recommends purchasing a spare filter cartridge so that you always have a clean substitute ready to rotate.
- 10 After the element has dried - if necessary, lightly brush between pleats with a fine paint-brush to remove remaining dirt particles.



**Do not use a wire brush or other device to clean cartridge element.**  
**Do not put in dishwasher or washing machine.**

### RE-INSTALLATION

- 11 Place the cartridge filter back into the filter housing.
- 12 Replace the filter housing lid, pushing it down to seat, ensuring that the lid o-ring does not become twisted.
- 13 HydroPool recommends that the lid o-ring be lubricated with a non-petroleum based lubricant (i.e. Silicone gel) when it becomes dry. This will help to prevent twisting and pinching as the lid is installed, and significantly increase longevity of the o-ring.
- 14 Install the filter lock-ring, turning clockwise until the lock tab snaps into place.
- 15 Close the air vent/bleeder valve.
- 16 Take the system out of **STANDBY/DRAIN ASSIST** mode.
- 17 When the pump starts circulating on low speed, it will be necessary to release trapped air in the filter. Carefully loosen the air vent/bleeder valve counter-clockwise until there is the hissing sound of air escaping. Once there is a steady stream of water, close the vent valve, ensuring that the o-ring does not become pinched.

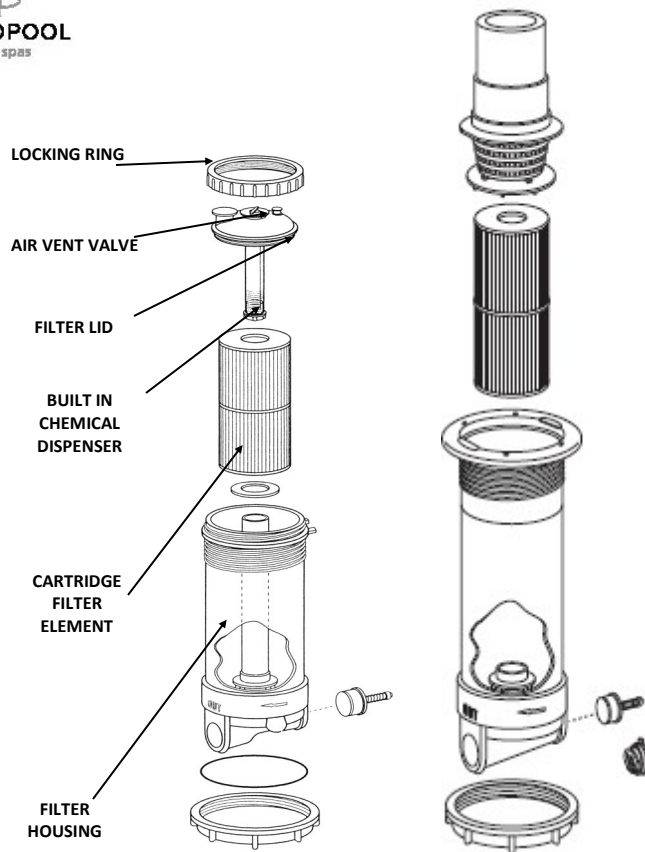

### CLEANING THE ACRYLIC SURFACE

The acrylic surface can be cleaned and polished using a soft cloth and acrylic cleaner, available at your HydroPool retailer.



- **Important: Do not use detergents - the remaining residues will adversely affect water chemistry, making it difficult to maintain proper water balance**
- **Do Not use abrasive cleaners – damage to the acrylic surface will occur.**

### NOTE:

**HYDROPOOL reserves the right to void the warranty of your spa if there is any indication of the use of products containing Hydrogen Peroxide.**

### CHANGING THE SWIM SPA WATER

The water in your swim spa must be carefully monitored and drained regularly as required, depending on size and amount of use. Draining at least once annually is strongly recommended and offers the opportunity for inspection of jets and suction fitting covers. If your swim spa is used daily or by a large number of bathers, the water should be drained more often. One method to determine the approximate length of time between water changes is to divide the water volume (in liters) of your swim spa by 13.5 and then divide by the average number of bathers each day.

#### Formula

$$\left( \frac{\text{Volume of water in liters}}{13.5} \right) \div \left( \frac{\text{Average daily bathers}}{\text{Days between water changes}} \right) = \text{Days between water changes}$$

Volume of water in liters      Average daily bathers      Days between water changes

#### EXAMPLE:

1000 liters divided by 13.5 divided by 2 = 37 days. The swim spa water must be changed when the amount of dissolved solids becomes excessive, and is usually indicated by "gray" or dull looking water.

### DRAINING YOUR SWIM SPA

#### REFER TO FIGURE 1 & FIGURE 2

- 1 Locate nearest drain facility (**Check your local bylaws**).
- 2 Put the hot tub control system into **STANDBY/DRAIN ASSIST** mode. The system will automatically exit Standby Mode after 1 hour and resume normal operating functions.
- 3 Remove the skimmer basket so that the hole beneath it is accessible, and insert the #10 rubber expansion plug or plastic threaded plug provided.
- 4 Attach garden hose to hose bib located on plumbing line beside the hot tub control system.
- 5 Run garden hose to drain location.
- 6 Open hose bib.
- 7 Close filtration pump return gate valve next to the hose bib (this directs the water out the drain hose).
- 8 Activate the circ pump.
- 9 Monitor the swim spa while it drains.
- 10 Use the second garden hose to wash down interior surface as the swim spa continues to drain. A sponge may also be used to wipe down the interior surface.

- 11 To completely flush the old water from the plumbing lines: allow fresh water to fill into the foot-well area while the old water continues to be pumped out. Always keep at least 10cm (4 in.) of water in the foot-well so that pump 1 remains primed.
- 12 When the water from the drain hose turns clear (indicating fresh fill water), flush is complete.
- 13 Turn OFF the filtration pump.
- 14 Close the drain-hose bib on the swim spa plumbing line and continue filling swim spa with fresh water.
- 15 Place cover on swim spa (to avoid splash-out).
- 16 Open filtration pump return gate valve.
- 17 Press any button on the topside control panel (other than the pump 1 button) to take the system out of **STANDBY/DRAIN ASSIST** mode. Filtration pump and the heater will activate to circulate and heat the water while filling continues. This also reduces the possibility of an airlock occurring.
- 18 Continue adding fresh fill water until level is approximately 19mm (3/4 in.) from the top of the skimmer opening.
- 19 Once fill is complete, remove the #10 rubber expansion plug from the bottom of the skimmer housing.\*
- 20 If the filter housing was opened to replace the cartridge filter, it will be necessary to release trapped air from the filter housing by carefully loosening the small black air vent/bleeder valve located on the top of the filter housing. When water begins to escape close the air vent valve.
- 21 In the unlikely event of a pump air lock (pump 1 is operating but there is no water movement from the jets), refer to section **PUMP PRIMING/RELEASING AN AIR LOCK**

\* It may be necessary to put system into **STANDBY/DRAIN ASSIST\* mode in order to remove plug.**

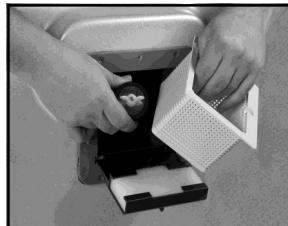

FIGURE 1

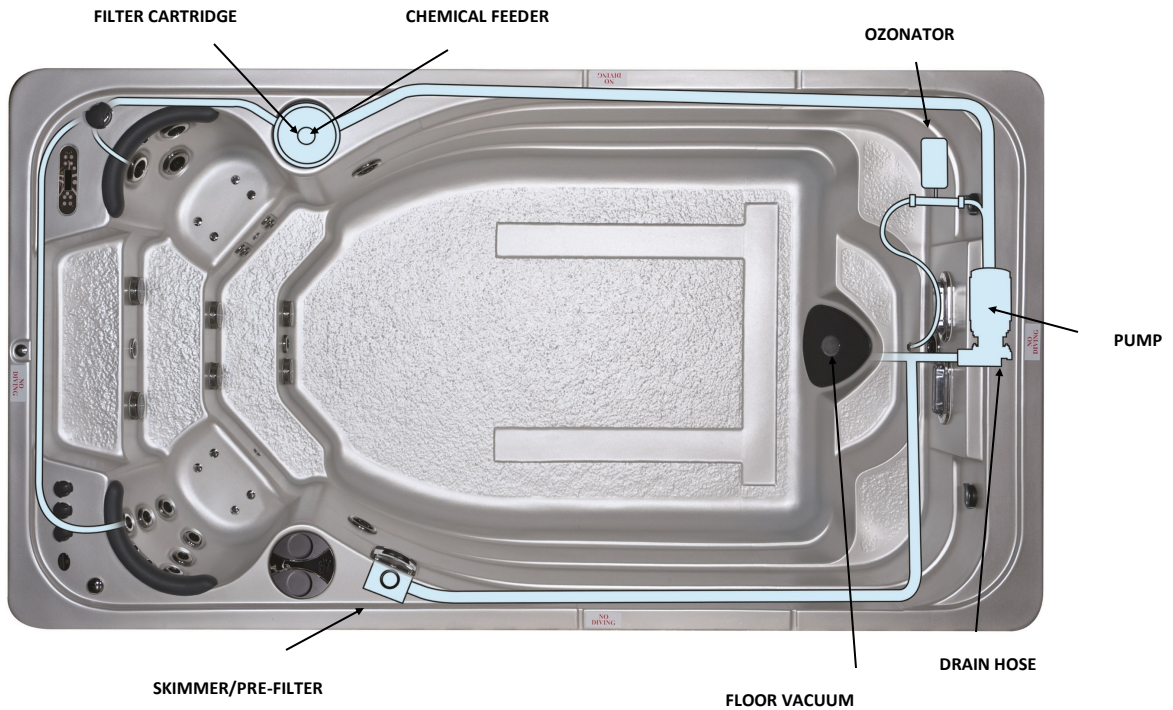

FIGURE 2

### WATER SOFTENERS

Never fill a swim spa with water from a water softener, as it could adversely effect the water chemistry, making it difficult to maintain proper water balance. If you live in an area with hard or soft water, give careful attention to your Calcium Hardness level. Topping up with soft water is acceptable.

### HYDROPOOL EXCLUSIVE QUICK-DRAIN™



#### THE SELF-CLEANING MODE INDICATOR



This worry-free indicator is located on the topside control display. The display will indicate **“Self Clean Mode”** on the display ensuring that the Self-Clean and Eco Heat Systems are both functioning and reassuring you of your family’s safety and protection.

## PROTECTING YOUR CABINET EVERLAST FINISH

**HYDROPOOL** swim spa cabinets are made from a unique, non-porous all-weather plastic material and with proper care will maintain its beauty for many years.

### CLEANING

Using hot soapy water and a stiff bristle brush, a soft cloth or sponge will remove surface dirt and grime. Stains can be removed with a water-based cleaner (E.g. Windex, Pledge, Simple Green, etc.). You can also use a power washer with a medium/ wide nozzle setting to clean the surface of the product. Cleaning every few months is recommended.



**...CAUTION:** Do not use cleaners containing aromatic solvents or harsh detergent /chemicals on “Everlast” material.

If dirt and surface contaminants are causing a dirty/brownish tint, an extra step can be taken. Use a 75% bleach and 25% water mixture and wipe the surfaces down. Allow the mixture to remain on the product for an hour, then rinse thoroughly. (Be sure to do this in a safe location and protect your eyes, skin, and wear old clothes).

### MAINTENANCE

Your **HYDROPOOL** ‘Everlast’ cabinet is made from a next-generation outdoor premium synthetic material. If the material is damaged during use (scratched or chipped), it can often be repaired.

Repairing Scratches — Take a very fine grade of steel wool (0000 grade) and “sand” the scratched area in the same direction that the embossing pattern runs. Apply enough pressure to gradually minimize the scratched area. Once the scratches are reduced, the surface area may appear dull and possibly even lighter in color; however, this will be less noticeable over time and with outdoor exposure. To finish the repair, apply liquid paste such as Finesse-it, furniture polish or carnauba wax and buff using auto paint repair buffing wheel to a finish.



## SOFT STRIDE FLOOR SYSTEM

The exclusive Soft Stride Floor System is available as a standard feature on the 13FFP Aquaplay and the Executive Series models to provide a better grip, traction and comfort on both the steps and floor of the swim spa. Making your swim spa safe and easy to use while getting in and out.

### Care & Maintenance Recommendations:

- Soft Stride Floor System cleans easily with soap, hot water and a brush (soft to medium bristle stiffness). Chlorine/bleach and water mixture, isopropyl rubbing alcohol or other household cleaners such as SoftScrub, Simply Green and 409 can be used to clean the pads.
- Be sure any soap or cleaning product is thoroughly rinsed from the pads and swim spa shell and this residue is removed before refilling the spa to prevent foaming.
- Always promptly attend to and clean any noticeable stains.

### Never:

- Allow coloured anti-freeze to puddle or dry on the mat.
- Allow stains to develop without promptly being attended to and cleaned.
- Clean with acid based cleanly products.
- Use acetone or mineral spirits on the pads or swim spa shell as damage caused to the swim spa shell from these chemicals will void the warranty.

## CARE OF STAINLESS STEEL

Hydro-pool uses stainless steel in a number of our swim spas. Its lasting beauty and resistance to corrosion make it an excellent material for handrails and jet faces.

With the proper care it will keep its luster for many years. All stainless steel can corrode given the right circumstances so we have provided a guide to help you keep the stainless components in your swim spa looking nice.

Stainless steel derives its ability to resist corrosion by forming a very thin transparent coating on the surface when exposed to oxygen. This coating can be damaged by abrasive materials such as steel wool, sand paper, and other cleaning materials that are abrasive. Chlorine salts, sulfides or other rusting metals can also erode this thin coating exposing the metal to corrosion.

The best defense to combat corrosion on stainless steel components in your swim spa is to make sure that it is kept clean and free of any chemical build up.

### Always:

- Clean frequently with fresh, clean water.
- Remove any rust spots as soon as they appear with vinegar or a brass, silver, or chrome cleaner.
- Use a good car cleaning wax for extra protection

### Never:

- Clean with mineral acids or bleaches.
- Clean with steel wool or any other abrasive material.
- Leave in contact with iron, steel or other metals.
- Close the cover immediately after adding chemicals to the water.

**NOTE:** Failure to take proper care of the stainless steel components could result with them rusting. Rusting is not covered by the warranty.

Do not cover the swim spa for 15 minutes after adding chemicals as the off gas can cause unwarranted damage. Larger dosages can require longer lengths of time to off gas. It is recommended to check the swim spa water more frequently to allow small dosages to be added as necessary versus large dosages being added less often.

## WINTERIZING YOUR HYDROPOOL SWIM SPA

In the event that you do not wish to use your swim spa year-round, it is very important that you properly winterize it to protect against damage from freezing. Your **HYDROPOOL** retailer can perform this service for a nominal fee. If you choose to winterize your swim spa yourself, please follow the directions outlined below:

1. Drain the swim spa tub entirely. See section - **DRAINING YOUR SWIM SPA**.
2. Remove and clean the filter cartridge. See section - **CARTRIDGE FILTER**.
3. Remove all of the jet inserts that are removable, any suction covers, water diverter cap(s) and waterfall control valve cap(s).
4. Using a wet / dry utility vacuum, remove remaining water from the jet openings, filter cartridge housing and footwell.
5. Using the blower side of the vacuum, position the blower nozzle into the top of the water diverter cap to blow out any water remaining in the plumbing lines so that the excess water will come out the jet bodies.
6. Replace all of the water diverter caps and waterfall control valve caps ensuring all gaskets are in place.
7. At the equipment end, loosen one union from each pump so that any excess water in each pump can be vacuumed out completely.
8. Either pour or use a turkey baster where necessary to add potable biodegradable RV antifreeze to areas such as pump wet ends, jet channels, filter housing and any blower channels.
9. Reinstall all jet inserts and all suction covers.

### DO NOT USE AUTOMOTIVE ANTIFREEZE.

- **Important:** mixing potable biodegradable RV antifreeze with water significantly reduces its ability to protect against freezing. Therefore, it is very important ALL water is removed from the hot tub plumbing before adding.
- Add potable RV antifreeze to the holes in the bottom suction/drain to prevent any trapped water in the false floor from freezing and damaging the hot tub shell.
- Turn pump on for only a few seconds to circulate the antifreeze.
- Unthread and disconnect all unions in the support equipment area. Remove lowest winter drain plug on pump face plate. Repeat for all pumps, where applicable.

- Cover exposed plumbing connections with plastic bags and duct tape.
- Where practical, disconnect swim spa support equipment and store in a dry heated area.
- Install the safety hardcover, and cover the entire hot tub with a tarp to prevent premature weathering of the cabinet and the safety hard cover.
- Remove snow build up regularly to prevent damage to the safety hard cover.
- It is assumed that your **HYDROPOOL** swim spa has been properly installed on a reinforced concrete pad to eliminate lifting of the hot tub due to hydrostatic ground water pressure.



**DRAIN PLUG LOCATIONS**

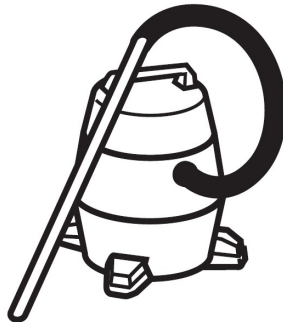

If you are not 100% confident that your hot tub is properly winterized, please consult your authorized **HYDROPOOL** Hot Tub Retailer. Caution recommends that an authorized **Hydropool** Retailer winterize your hot tub in the initial year. Damage as a result of freezing is not covered by the warranty.



## GENERAL TROUBLESHOOTING

### WHAT TO DO IN THE EVENT OF POWER FLUCTUATIONS

The power supply into your home is, for the most part, fairly consistent.

However, when local power demand is high, there is a tendency for the voltage entering your home to drop (sometimes significantly) or fluctuate.

This condition is referred to as a 'brown-out'. Although safeguards have been built into the system to protect against this condition, supply voltage may drop low enough, if even for a second, to cause the system to display a 'ghost' message. Should this occur or if the display shows partial messages, try resetting the system by turning power to the swim spa, waiting a few minutes, then turning power on again. If this does not reset the system, contact your local **HYDROPOOL** retailer or service organization.

### POWER FAILURE OR SYSTEM FAULT DURING COLD WEATHER CONDITIONS

If your control system will not reset, (i.e. GFCI trips) or if your pump will not circulate for any other reason, place a low wattage space heater under the cabinet in the equipment area. This will delay the risk of freezing while a service appointment is scheduled.



**Always follow the manufacturers instructions when locating and placing a portable electric space heater into service. Ensure that safe clearance to combustible surfaces is maintained. Do not leave unattended.**

## NOTES:

**IN.YE-3 EU WIRING DIAGRAM**

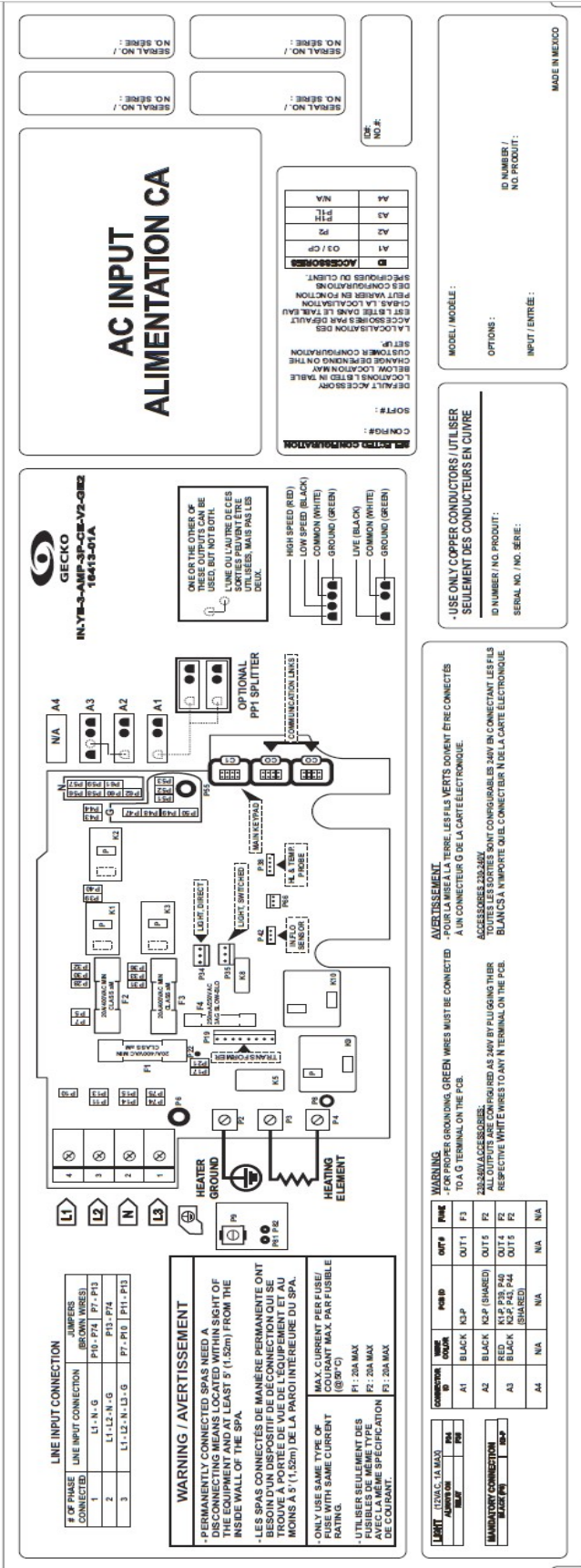

**\*\*\* Pour toute modification, vérifier si des changements aux instructions d'assemblage sont à faire. \*\*\***

# IN.YE-3 NA WIRING DIAGRAM

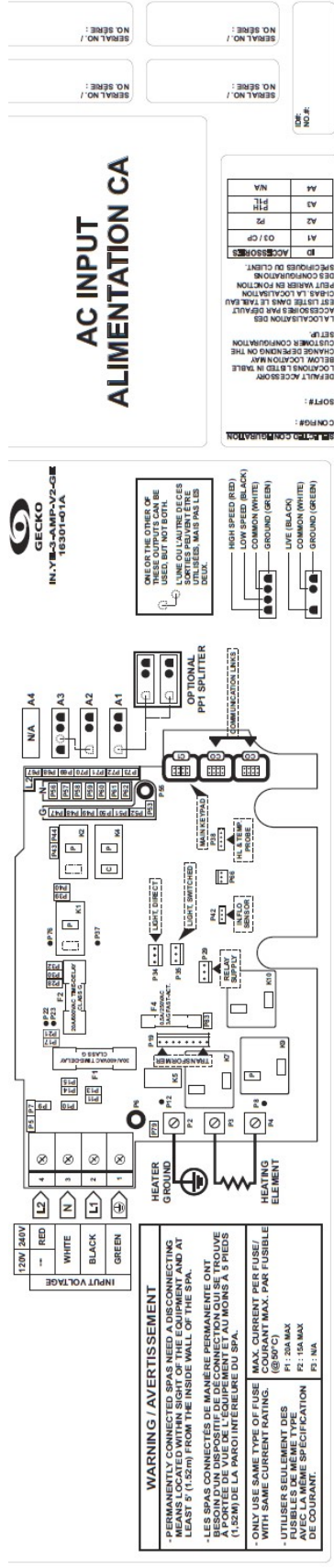

**WARNING / AVERTISSEMENT**

- PERMANENTLY CONNECTED SPAS NEED A DISCONNECTING MEANS LOCATED WITHIN SIGHT OF THE EQUIPMENT AND AT LEAST 5' (1.52m) FROM THE INSIDE WALL OF THE SPA.  
- LES SPAS CONNECTÉS DE MANIÈRE PERMANENTE ONT À PORTÉE DE VUE DE L'ÉQUIPEMENT ET AU MOINS 5 PIEDS (1.52M) DE LA PAROI INTÉRIEURE DU SPA.

- ONLY USE SAME TYPE OF FUSE / MAX. CURRENT PER FUSE / COMPACT MAX. PAR FUSIBLE WITH SAME CURRENT RATING.  
- UTILISER SEULEMENT DES COMPOSANT MAX. PAR FUSIBLE AVEC LA MÊME SPÉCIFICATION DE COURANT.

F1: 20A MAX  
F2: 11A MAX  
F3: N/A

**CONNECTIONS:**

CONNECTION	WIRE	TYPE	WIRE
A1	BLACK	N/P, P3, P46	OUT 1
A2	BLACK	P27 (SHARED)	OUT 2
A3	BLACK	P27 (SHARED)	OUT 1
A4	N/A	N/A	N/A

**HEATER GROUND:** RED, WHITE, BLACK, GREEN

**HEATING ELEMENT:** P1, P2, P3, P4, P5, P6, P7, P8, P9, P10, P11, P12, P13, P14, P15, P16, P17, P18, P19, P20, P21, P22, P23, P24, P25, P26, P27, P28, P29, P30, P31, P32, P33, P34, P35, P36, P37, P38, P39, P40, P41, P42, P43, P44, P45, P46, P47, P48, P49, P50, P51, P52, P53, P54, P55, P56, P57, P58, P59, P60, P61, P62, P63, P64, P65, P66, P67, P68, P69, P70, P71, P72, P73, P74, P75, P76, P77, P78, P79, P80, P81, P82, P83, P84, P85, P86, P87, P88, P89, P90, P91, P92, P93, P94, P95, P96, P97, P98, P99, P100

**MODEL / MODÈLE:**

**OPTIONS:**

**INPUT / ENTRÉE:**

MADE IN MEXICO

**NO. SÉRIE / NO. SÉRIE:**

**ID NUMBER / NO. PRODUIT:**

**CONNECTIONS:**

CONNECTION	WIRE	TYPE	WIRE
A1	BLACK	N/P, P3, P46	OUT 1
A2	BLACK	P27 (SHARED)	OUT 2
A3	BLACK	P27 (SHARED)	OUT 1
A4	N/A	N/A	N/A

**WARNING / AVERTISSEMENT**

- ALL GREEN WIRE MUST BE CONNECTED TO A 0 TERMINAL ON THE PCB.  
- ALL OUTPUT FACTORY SHIPPED AS 240V.

**ACCESSORIES / 120V:**

- TO USE THESE DEVICES, THESE SORTIES DOIVENT ÊTRE CONNECTÉES À UN CONNECTEUR 0 DE LA CARTE ÉLECTRONIQUE.

**ACCESSORIES / 240V:**

- TO USE THESE DEVICES, THESE SORTIES DOIVENT ÊTRE CONNECTÉES À UN CONNECTEUR 0 DE LA CARTE ÉLECTRONIQUE.

**WARNING / AVERTISSEMENT**

- ALL GREEN WIRE MUST BE CONNECTED TO A 0 TERMINAL ON THE PCB.  
- ALL OUTPUT FACTORY SHIPPED AS 240V.

**ACCESSORIES / 120V:**

- TO USE THESE DEVICES, THESE SORTIES DOIVENT ÊTRE CONNECTÉES À UN CONNECTEUR 0 DE LA CARTE ÉLECTRONIQUE.

**ACCESSORIES / 240V:**

- TO USE THESE DEVICES, THESE SORTIES DOIVENT ÊTRE CONNECTÉES À UN CONNECTEUR 0 DE LA CARTE ÉLECTRONIQUE.

**WARNING / AVERTISSEMENT**

- ALL GREEN WIRE MUST BE CONNECTED TO A 0 TERMINAL ON THE PCB.  
- ALL OUTPUT FACTORY SHIPPED AS 240V.

**ACCESSORIES / 120V:**

- TO USE THESE DEVICES, THESE SORTIES DOIVENT ÊTRE CONNECTÉES À UN CONNECTEUR 0 DE LA CARTE ÉLECTRONIQUE.

**ACCESSORIES / 240V:**

- TO USE THESE DEVICES, THESE SORTIES DOIVENT ÊTRE CONNECTÉES À UN CONNECTEUR 0 DE LA CARTE ÉLECTRONIQUE.

**WARNING / AVERTISSEMENT**

- ALL GREEN WIRE MUST BE CONNECTED TO A 0 TERMINAL ON THE PCB.  
- ALL OUTPUT FACTORY SHIPPED AS 240V.

**ACCESSORIES / 120V:**

- TO USE THESE DEVICES, THESE SORTIES DOIVENT ÊTRE CONNECTÉES À UN CONNECTEUR 0 DE LA CARTE ÉLECTRONIQUE.

**ACCESSORIES / 240V:**

- TO USE THESE DEVICES, THESE SORTIES DOIVENT ÊTRE CONNECTÉES À UN CONNECTEUR 0 DE LA CARTE ÉLECTRONIQUE.

**\*\*\* Pour toute modification, vérifier si des changements aux instructions d'assemblage sont à faire. \*\*\***

REV	DATE	BY	APPV
A	APR 16	C.C.	
4610, Des Composites (Canada)    Tél: (416) 872-4411 4610, Des Composites    Fax: (416) 872-0020 4610, Des Composites			
DESCRIPTION IN.YE-3-AMP-V2-GE		DESIGNED BY: G.OWEN DATE: APR 05, 2016 VERIFIED BY: [ ] DATE: [ ]	
MODEL / MODÈLE IN.YE-3-AMP-V2-GE		PART NUMBER / NO. PRODUIT 16301-01A	
SERIAL NO. / NO. SÉRIE 16301-01A		ORDER NO. / NO. COMMANDE 16301-01A	
DATE OF MANUFACTURE / DATE DE FABRICATION APR 05, 2016		DATE OF RECEIPT / DATE DE RÉCEPTION APR 05, 2016	
NUMBER OF PAGES / NOMBRE DE PAGES 1 DE 1		TOTAL PAGES / TOTAL DES PAGES 1 DE 1	

# IN.YE-5 EU WIRING DIAGRAM

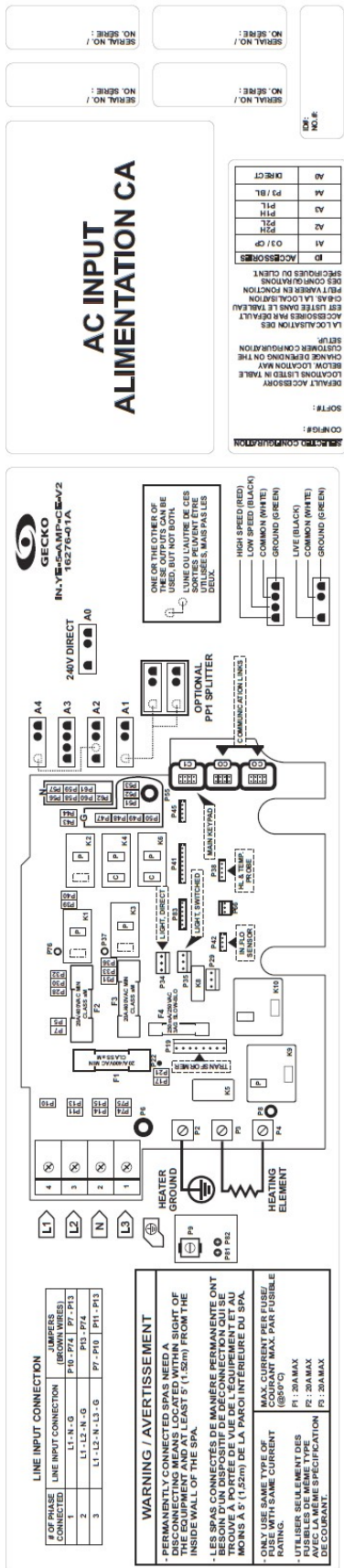

**MODEL / MODELE :**

**OPTIONS :**

**NO. PARTS / NO. PIÉCES :**

**MADE IN MEXICO**

**AVERTISSEMENT**

SEULEMENT DES CONDUCTEURS EN CUivre

ID NUMBER / NO. PRODUIT :

SERIAL NO. / NO. SÉRIE :

**WARNING / AVERTISSEMENT**

PERMANENTLY CONNECTED SPAS MUST BE CONNECTED TO A GROUND TERMINAL ON THE PCB.

LES SPAS CONNECTÉS DE MANIÈRE PERMANENTE DOIVENT ÊTRE CONNECTÉS À UN TERMINAL G DE LA CARTE ÉLECTRONIQUE.

ALL OUTPUTS ARE CONFIGURED AS MAY BE PLUGGING THEIR RESPECTIVE WHITE WIRES TO ANY TERMINAL ON THE PCB.

TOUTES LES SORTIES SONT CONFIGURABLES D'APRÈS EN CONNECTANT LES FILS BLANCS À N'IMPORTE QUEL CONNECTEUR DE LA CARTE ÉLECTRONIQUE.

**MANDATORY CONNECTION**

MANDATORY CONNECTION	WIRING
A1	Q1 / QP
A2	P1 / BL
A3	P1L
A4	P1R
A5	P1L
A6	DIRECT

**\*\*\* Pour toute modification, vérifier si des changements aux instructions d'assemblage sont à faire. \*\*\***

NO.	DESCRIPTION	DATE	APP.
A	ORIGINAL	MAR 16	C.C.
<p><b>GECKO</b></p> <p>LOGO: 6276-D1A</p> <p>PRINT DATE: MAR 23, 2016</p> <p>CONTRACT NO. MAFR_23_2016</p> <p>CONTRACTOR: TEL: (415) 872-4411 FAX: (415) 872-0900</p> <p>DESCRIPTION: WIRING DIAGRAM IN.YE-5AMP-CE-V2</p> <p>ESTIMATE NO.: C-0404</p> <p>DATE: MAR 23, 2016</p> <p>VERIFIED DATE:</p> <p>DATE: _____</p> <p>NO. OF SHEETS: _____</p> <p>SHEET NO. OF SHEET: _____</p> <p>NO. OF PAGES: _____</p> <p>SHEET NO. OF PAGES: _____</p>			



**IN.YE-5 NA WIRING DIAGRAM**

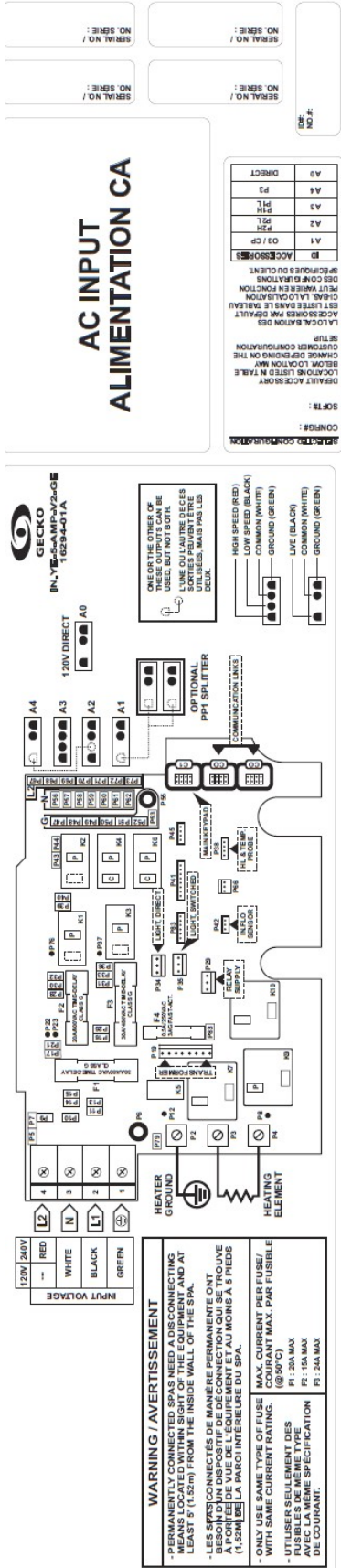

**AC ACCESORIES**

A0	DIRECT
A4	
A3	
A2	
A1	CP / CP

NO #:

SERIAL NO. / NO SERIE:

MODEL / MODELE:

OPTIONS:

ID NUMBER / NO. PRODUCT:

INPUT / ENTREE:

MADE IN MEXICO

**WARNING**  
-FOR PROPER GROUNDING GREEN WIRES MUST BE CONNECTED TO A G TERMINAL ON THE PCB.  
-TOUTES LES SORTIES SONT CONFIGURABLES 240V EN CONNECTANT LES PLS BLANCS A L'IMPORTE QUEL CONNECTEUR N DE LA CARTE ELECTRONIQUE.

**AVERTISSEMENT**  
-POUR LA MISE A LA TERRE LES PLS VERTS DOIVENT ETRE CONNECTES A UN CONNECTEUR G DE LA CARTE ELECTRONIQUE.  
-TOUTES LES ACCESSOIRES (SAUF A0) CONFIGURES EN 240V PAR DEFAUT.

**240V ACCESSORIES**  
ALL OUTPUTS MAY BE CONFIGURED AS 120V BY PLUGGING THEIR RESPECTIVE WHITE WIRES TO ANY N TERMINAL ON THE PCB.

**240V ACCESSOIRES**  
TOUTES LES SORTIES SONT CONFIGURABLES 120V EN CONNECTANT LES PLS BLANCS A L'IMPORTE QUEL CONNECTEUR N DE LA CARTE ELECTRONIQUE.

COMPONENT ID	WIRE COLOR	WIRE ID	WTF#	PUSH
A1	BLACK	K1-P, P38, P40	OUT4	P38
A2	RED	K2-P, P39, P42	OUT1	P39
A3	BLACK	K3-P, P43, P44	OUT3	P43
A4	BLACK	K5-P, P45, P46	OUT5	P45
A0	BLACK	K6-P, P26, P32	DIRECT	P26

HEATER VOLTAGE	WIRE	WTF#	PUSH
120V	RED	P1	
120V	WHITE	P2	
120V	BLACK	P3	
120V	GREEN	P4	

LEAK TEST CONNECTIONS:  
BLU/WHY (P1)  
BLU/WHY (P2)  
BLU/WHY (P3)

**\*\*\* Pour toute modification, vérifier si des changements aux instructions d'assemblage sont à faire. \*\*\***

A	ORIGINAL	MAR 16	C-C
NO	REVISION	DATE	REV
		NO	APP.
FICHER: 16289-01A			
LOGICIEL: CODELDRW 12			
PRINT DATE: MAR, 31, 2016			
CONCURRENCE: DATE			
DESIGNEUR: G. CHAMAKA			
DATE: MAR, 31, 2016			
TYPE: WIRING DIAGRAM			
IN.YE-5-NA-GE			
PROJETS:			
NUMERIQUE PROJE: POINTEVILLE			
DATE:			
REV:			
REV 1 DE 1			

**GECKO**

1500, Chem. du Châtelet, Tel.: (418) 872-4411  
Châtelet, Québec, P.Q. Fax: (418) 872-0920

DESCRIPTION: WIRING DIAGRAM  
IN.YE-5-NA-GE

PROJETS:

NUMERIQUE PROJE: POINTEVILLE

DATE:

REV:

REV 1 DE 1